

# User Guide

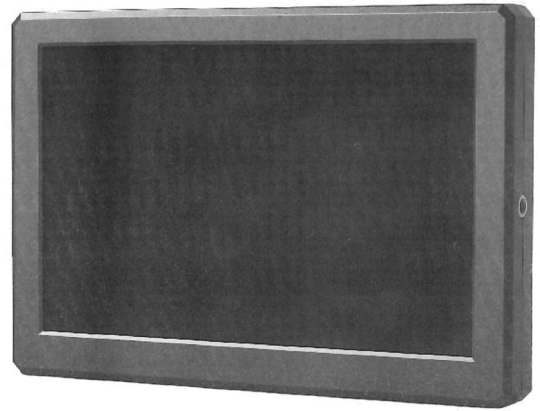

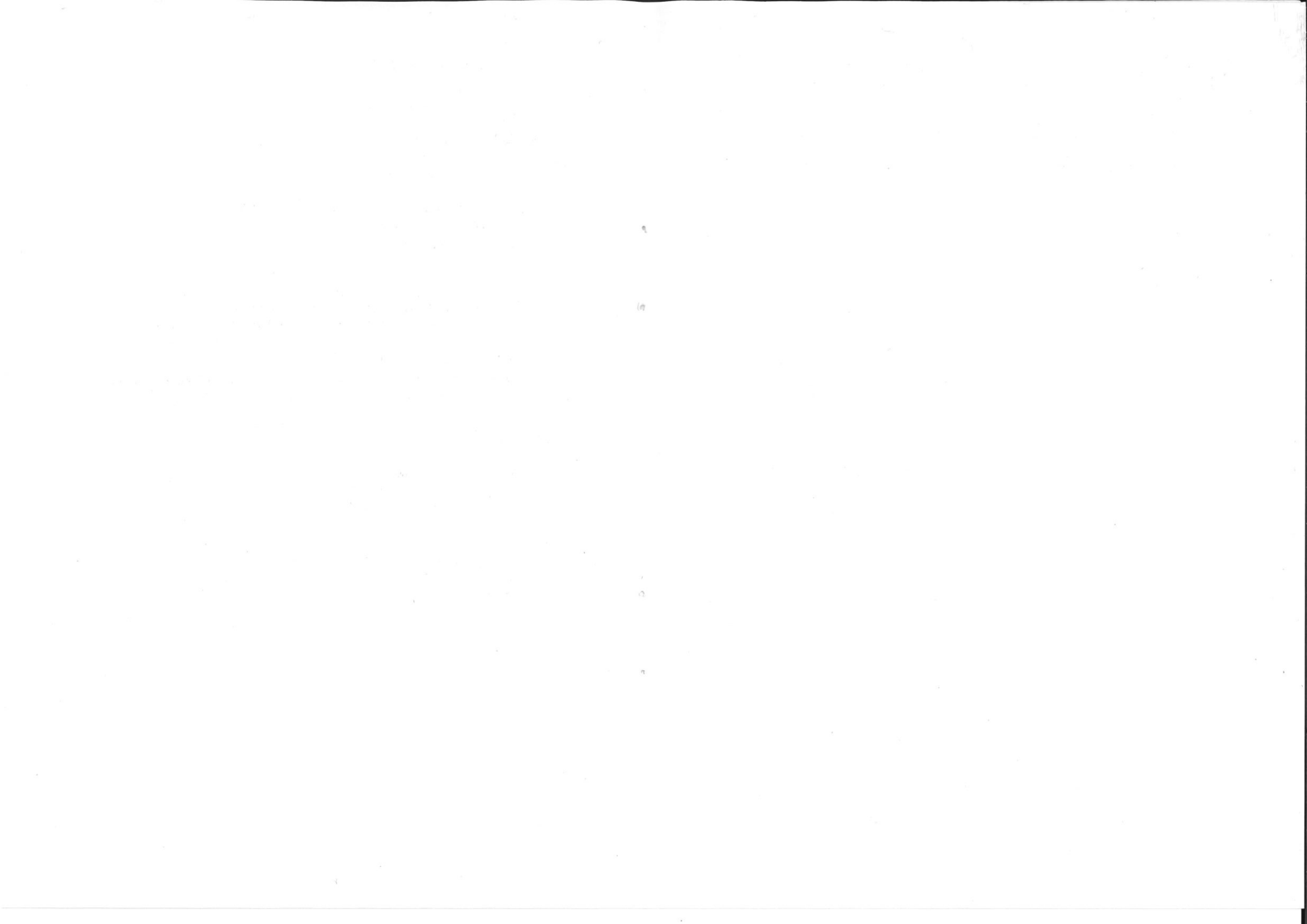

not quality issue but the character of LG screen, so no warranty/  
return/exchange for such situation.

Note: Due to constant effort to improve products and product  
features, specifications may change without priority notice.

### IMPORTANT SAFETY INSTRUCTIONS:



The device has been tested for conformance to safety regulations and requirements, and has been certified for international use. However, like all electronic equipment, the device should be used with care. Please read and follow the safety instructions to protect yourself from possible injury and to minimize the risk of damage to the unit.

- Please do not place the display screen towards the ground to avoid scratching the LCD surface.
- Please avoid heavy impact.
- Please do not use chemical solutions to clean this product. Simply wipe with a clean soft cloth to maintain the brightness of the surface.
- Please do not block any vent hole.
- Please follow the instructions and trouble-shooting to adjust the product.
- Internal adjustments or repairs must be performed by a qualified technician.
- Please keep user guide for future reference.
- Please unplug the power and remove the battery if long-term no-use, or thunder weather.

### FEATURES:

- 4K HDMI input & loop output
- 1920x1200, Full HD resolution
- 350cd/m<sup>2</sup> high brightness
- 800:1 high contrast
- Wide Voltage: DC7-24V
- Plenty of Camera Auxiliary Functions

YP-01181126

# CONTENT

1. PRODUCT DESCRIPTION.....	3
2. BATTERY INSTALLATION.....	5
3. MENU SETTING.....	6
4. ACCESSORIES.....	21
5. PARAMETER.....	22
6. TROUBLE SHOOTING.....	23

## 6. TROUBLE SHOOTING

1. Only black-and-white display:  
Check whether the color saturation is properly setup or not.
2. Power on but no pictures:  
Check whether the cables of DP, HDMI, and 3G-SDI are correctly connected or not. Please use the standard power adapter coming with the product package. Improper power input may cause damage.
3. Wrong or abnormal colors:  
Check whether the cables are correctly and properly connected or not. Broken or loose pins of the cables may cause a bad connection.
4. When on the picture shows size error:  
Press "MENU → FUNCTION → Underscan" to zoom in/out pictures automatically when receiving HDMI signals
5. Other problems:  
Please press Menu button and choose "MENU→SYSTEM→ Reset →ON".
6. According to the ISP, the machine can not function properly:  
ISP for program upgrades, non-professionals do not use. Please reboot your device if press accidentally!
7. Image Ghosting  
If continue to display the same image or words on the screen for a long period of time, part of that image or words may burn into the screen and leave a ghosting image behind. Please understand it's

## 5. PARAMETER

Display Screen	8" IPS
Physical Resolution	1920×1200
Brightness	350 cd/m <sup>2</sup>
Contrast	800: 1
Viewing Angle	170°/ 170°(H/V)
Input Voltage	DC 7-24V
Input	HDMI , SDI
Output	HDMI , SDI
Power Consumption	≤10W
Operating Temperature	0°C~50°C
Storage Temperature	-10°C~60°C
Dimension (LWD)	225×155×23mm
Weight	535g

## 1. PRODUCT DESCRIPTION

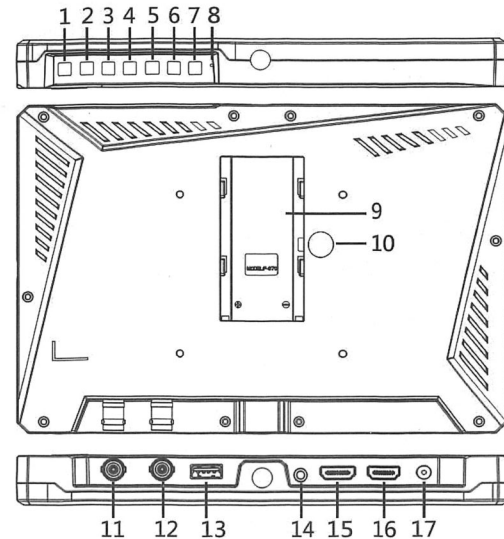

### 1 . MENU button:

Menu key: Press to display menu on the screen when screen is lit.

Switch key: Press ► / ◀ to activate Volume when out of Menu, then press MENU to switch the functions among Volume, Brightness, Contrast, Saturation, Tint, Sharpness, Exit and Menu.

Confirm key: press to confirm the selected option.

- 2 . ► Right selection key: Select option in the menu. Increase the option value.
- 3 . ◀ Left selection key: Select option in the menu. Decrease the option value.

4 . EXIT/F2 :

Exit : To return or exit the menu function.

F2 User-definable function button: Press to activate user-definable

function when out of Menu.

Default: Level Meter.

5 . F1 : User-definable function button

Default: Peaking

6 . INPUT: Switch the signal among HDMI and SDI.

7 .  : Power on/off.

8 . Power indicator light . : Standby is red.

9 . Battery slot.

10 . Battery release button.

11 . SDI signal input interface.

12 . SDI signal output interface.

13 . UPGRADE : Log update USB interface.

14 . Earphone jack.

15 . HDMI signal input interface.

16 . HDMI signal output interface.

17 . DC 12V power input.

## 4. ACCESSORIES

### Standard:

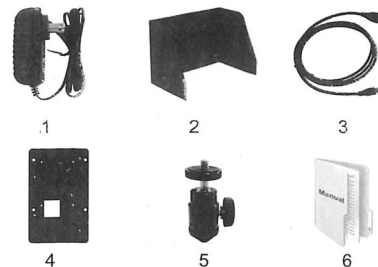

- |    |                         |       |
|----|-------------------------|-------|
| 1. | 12V DC adapter          | 1pc   |
| 2. | Folding sun shade cover | 1pc   |
| 3. | HDMI A/C cable          | 1pc   |
| 4. | VESA Battery plate      | 1pc   |
| 5. | Shoe mount              | 1pc   |
| 6. | User manual             | 1copy |

### Optional:



- |    |                              |     |
|----|------------------------------|-----|
| 1. | V-mount or Anton bauer mount | 1pc |
| 2. | Li-ion Battery (F970)        | 1pc |



Back Light

Adjusts the level of the back light level from 0-100. If the back light value is increased, the screen becomes brighter.

F1 Configuration & F2 Configuration

Select F1 or F2 "Configuration" for setting. Functions of F1-F2 buttons can also be customized: Center Marker, Aspect Marker, Check Filed, Underscan, Scan, Aspect, DSLR, Freeze, Peaking, False Color, Exposure, Histogram, Level Meter.

Default function:

F1 : Peaking      F2 : Level Meter

After set up it, the user can press F1 or F2 to pop up the function directly on screen.

Reset

If there is any problem unknown, press to confirm after selected. The monitor will return to default set.

## 2. BATTERY INSTALLATION

Standard mounts process

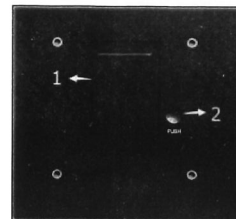

- ① Place battery to the slot, and then slide it down to finish mounting.
- ② Press the battery release button, and then slide battery up to take it out.

### DV Battery Mount Plate Specification

Model F970 for battery of SONY DV:

DCR-TRV series, DCR-TRV E series, VX2100E PD P series, GV-A700, GV-D800 FD/CCD-SC/TR3/FX1E/HVR-AIC, HDR-FX1000E, HVR-Z1C, HVR-V1C, FX7E F330.

### 3. MENU SETTING

Before setting the functions, please make sure the device is connected correctly.

#### 3-1. F1~F2 User-definable function buttons:

Select "MEMU -- SYSTEM -- F1 Configuration/F2 Configuration" to custom F1 / F2 shortcut settings. Press "◀ / ▶" to choose the function, then press MENU to confirm option as default.

Functions of F1-F2 buttons can also be customized: Center Marker, Aspect Marker, Check Filed, Underscan, Scan, Aspect, DSLR, Freeze, Peaking, False Color, Exposure, Histogram, Level Meter.

Default function:

F1 : Peaking      F2 : Level Meter

#### 3-2. MENU OPERATION

When power on, press "MENU" button on the device. The menu will display on the screen. Press "◀ / ▶" button to choose menu item.

Then press "MENU" button to confirm.

Press EXIT/F2 to return or exit the menu.

0. This is the maximum level, meaning that any audio that exceeds this level will be clipped, resulting in distortion. Ideally peak audio levels should fall in the upper end of the green zone. If the peaks enter into the yellow or red zones, the audio is in danger of clipping.

#### 3-2-6.SYSTEM

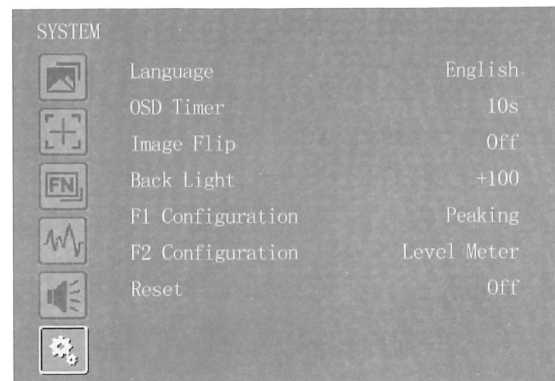

##### Language

Switch between English and Chinese.

##### OSD TIMER

Select the displaying time of the OSD. It has 10s, 20s, 30s preset to choose.

##### Image Flip

The monitor support H, V, H/V three preset Flip modes.



information falls off gradually at the edges of the histogram with most forming around the middle. This will give the user more freedom later to adjust colors without whites and blacks appearing flat and lacking in detail.

### 3-2-5. AUDIO

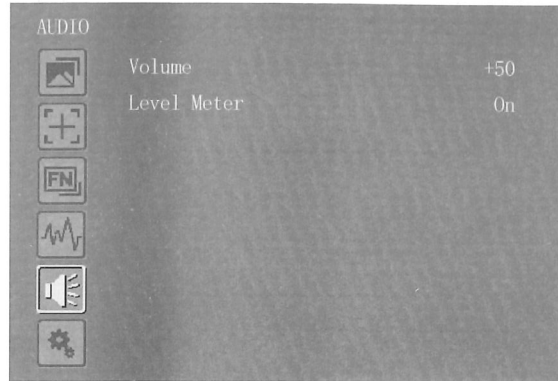

#### Volume

To adjust the volume for 0-100 for the built in speaker and earphone jack audio signal.

#### Level Meter

The left side of the on screen meters displays level meters showing audio levels for channels 1 and 2 of the input source. It features peak hold indicators which stay visible for a short time so the user can clearly see the maximum levels reached.

To achieve optimum audio quality, ensure the audio levels do not reach

### 3-2-1. PICTURE

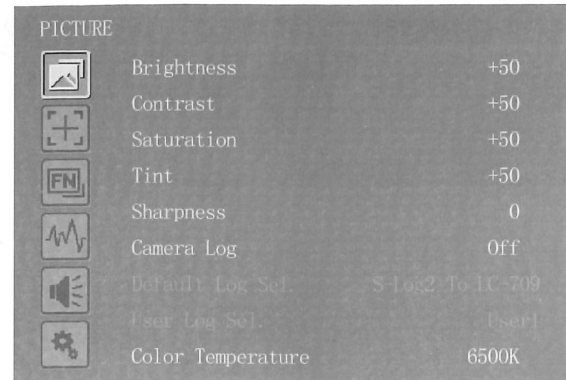

#### Brightness

Adjust the general brightness of the LCD from 0-100. For example, if the user is outside in bright conditions, increase the LCD brightness to make it easier to view.

#### Contrast

Increases or decreases the range between the bright and dark areas of the image. High contrast can reveal detail and depth in the image, and low contrast can make the image appear soft and flat. It can be adjusted from 0-100.

#### Saturation

Adjust the color intensity. Turn the knob right to increase the color intensity and turn left to decrease it.

#### Tint

It can be adjusted from 0-100.

## Sharpness

Increase or decrease the sharpness of the image. When the image sharpness is insufficient, increase the sharpness to make the image clearer. It can be adjusted from 0-100.

## Camera Log

Use this setting to choose one of the camera Log modes:

-[Off]: Sets off Camera Log.

-[Default Log]

Use this setting to choose one of the Camera Log modes:

SLog2ToLC-709, SLog2ToLC-709TA, SLog2ToSLog2-709,

SLog2ToCine+709, SLog3ToLC-709, SLog3ToLC-709TA,

SLog3ToSLog2-709, SLog3ToCine+709.



-[User Log]

Use this setting to choose one of the User Log modes (1-6).

Please install the User Log as following steps:

The User Log must be named with .cube in the suffix.

The histogram shows the distribution of the luminance or the black to white information along a horizontal scale, and lets the user monitor how close the detail is to being clipped in the blacks or whites of the video. The histogram also lets you see the effects of gamma changes in the video.

The left edge of the histogram displays shadows, or blacks, and the far right displays highlights, or whites. If monitoring the image from a camera, when the user closes or opens the lens aperture, the information in the histogram moves to the left or right accordingly. The user can use this to check "clipping" in the image shadows and highlights, and also for a quick overview of the amount of detail visible in the tonal ranges. For example, a tall and broad range of information around the middle section of the histogram corresponds to good exposure for details in the midtones of your image.



Under exposure

Over exposure

Proper exposure

The video is likely being clipped if the information bunches to a hard edge at 0% or above 100% along the horizontal scale. Video clipping is undesirable when shooting, as detail in the blacks and whites must be preserved if the user subsequently wants to perform color correction in a controlled environment. When shooting, try to maintain the exposure so

exposure. As the camera Iris is adjusted, elements of the image will change color based on the luminance or brightness values. This enables proper exposure to be achieved without the use of costly, complicated external equipment.

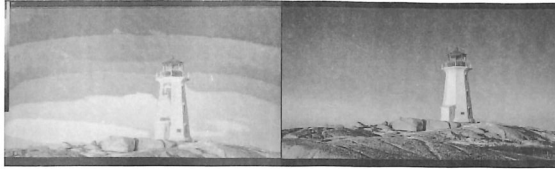

#### Exposure & Exposure Level

The exposure feature helps the user achieve optimum exposure by displaying diagonal lines over areas of the image that exceed the setting exposure level.

The exposure level can be set to 0~100.

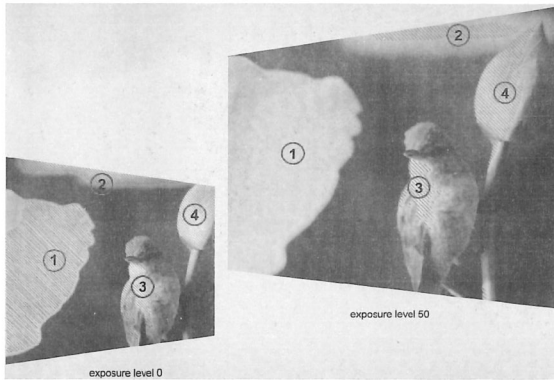

#### Histogram

Please note: the device only support the format of User Log:

17x17x17 , Data format is BGR, Table format is BGR.

If the format does not meet the requirement, please use tool "Lut Tool.exe" to transform it. Naming the User Log as User1~User6.cube, then copy the user Log into USB flash disk (Only support USB2.0 versions). Insert the USB flash disk to the device, the User Log is saved to the device automatically at the first time. If the User Log is not loaded for the first time, the device will pop up a prompt message, please choose whether to update or not. If there is not a prompt message, please check the format of document system of the USB flash disk or format it (The document system format is FAT32). Then try it again.

#### Color Temp

Adjust the color temperature to make the image warmer (Yellow) or colder (Blue). Increase the value to make the image be warmer, decrease the value to make the image be colder. User can use this function to strengthen, weaken or balance the image color according requirements. The standard white light color temperature is 6500K.

Color Gain/Offset is available only under "User" mode to choose the color value.

### 3-2-2.MARKER

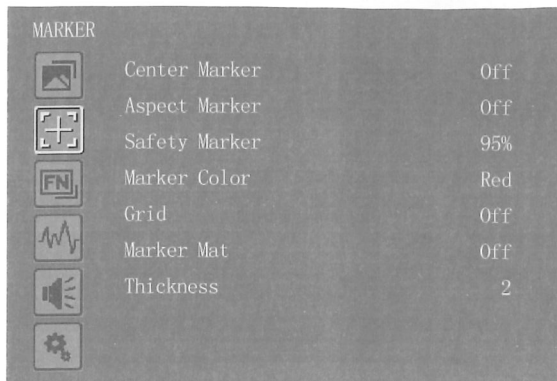

Marker	Center Marker	ON, OFF
	Aspect Marker	OFF, 16:9, 1.85:1, 2.35:1, 4:3, 3:2
	Safety Marker	OFF, 95%, 93%, 90%, 88%, 85%, 80%
	Marker Color	Red, Green, Blue, White, Black
	Grid	OFF, ON
	Marker Mat	OFF, 1, 2, 3, 4, 5, 6, 7
	Thickness	2, 4, 6, 8

#### Center Marker

Select On, it will appear "+" marker on center of screen.



#### Aspect Marker

The Aspect Marker provides various aspect ratios, as the following:

The peaking is used to aid the camera operator in obtaining the sharpest possible picture. Select "On" to display colored outlines around sharp areas of the image.

#### Peaking Color

Use this setting to change the color of focus assist lines to Red, Green, Blue, White, Black. Changing the color of the lines can help make them easier to see against similar colors in displayed image.

#### Peaking level

Use this setting to adjust the level of focus sensitivity. If there are plenty of details of image with high contrast, it will display lots of focus assist lines that may cause visual interference. So, decrease the value of peaking level to reduce the focus lines to see clearly. Conversely, if the image has less details with low contrast, it should be increase the value of peaking level to see the focus lines clearly.

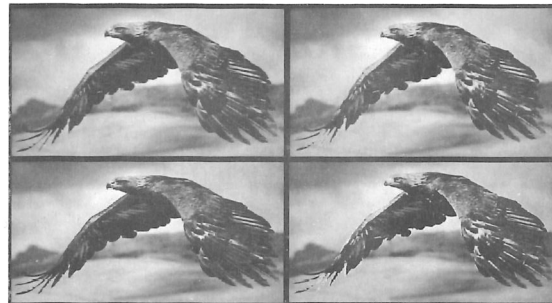

#### False Color

This monitor has a false color filter to aid in the setting of camera

## Underscan

If the image shows size error, use this setting to zoom in/out pictures automatically when receiving HDMI signals

## Check Field

Use the check field modes for monitor calibration or to analyze individual color components of an image. In Mono mode, all color is disabled and only a grayscale image is shown. In Blue, Green, and Red check field modes, only the selected color will be shown.

## DSLR

Use the DSLR Preset option to reduce the visibility of on screen indicators shown with popular DSLR cameras. The available options are: 5D2, 5D3. This function is available only under HDMI mode.

### 3-2-4. WAVEFORM

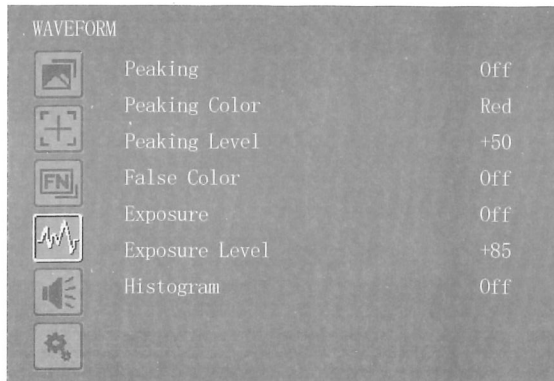

#### Peaking



## Safety Marker

Used to select and control the size and availability of the safety area. Available type are OFF, 95%, 93%, 90%, 88%, 85%, 80% preset to choose. Grid

The grid feature displays a "thirds" overlay with two vertical and horizontal lines placed in each third of the image. Select "ON" or "OFF" to view or hide the thirds overlay.

"Thirds" are an extremely powerful tool to help compose the shots. For example, the human eye typically looks for action near the points where the lines intersect, so it's help to frame key points of interest in these zones.

Note: Grid function is unavailable while activate Marker Mat.

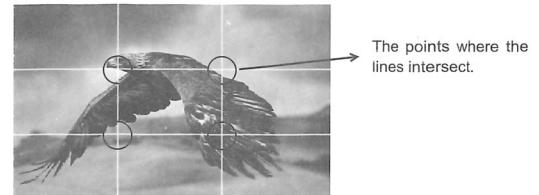

## Marker Color & Marker Mat & Thickness

Marker Mat darkens the area of the outside of Marker. The degrees of darkness are between 0 to 7. Marker Color controls the color of the marker lines and the thickness controls the thickness of the marker lines.

Users can choose abundant ratios or colors according to different background colors when shooting.



### 3-2-3.FUNCTION

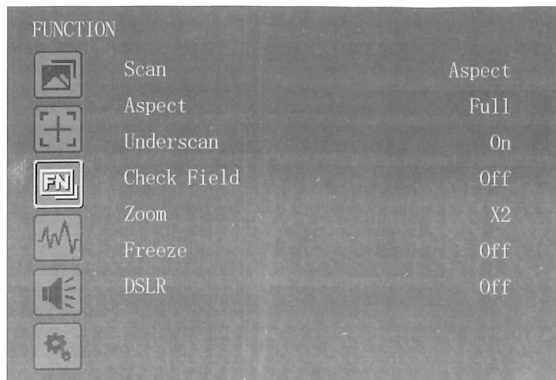

#### Scan

Use this menu option to choose Scan mode. There are three modes preset:

- Aspect:

Select Aspect under Scan option, then use Aspect option to switch between several aspect ratio setting. For example:

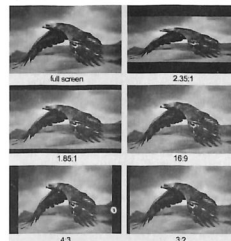

In 4:3 mode, images are scaled up or down to fill the maximum 4:3 portion of the screen.

In 16:9 mode, images are scaled to fill the entire screen.

In Full mode, images are scaled to fill the entire screen.

- Pixel to Pixel

The pixel to pixel is a monitor set to 1:1 pixel mapping with native fixed pixels, which avoids loss of sharpness due to scaling artifacts and normally avoids incorrect aspect ratio due to stretching.

Function	Scan	Aspect, Pixel To Pixel, Zoom
	Aspect	Full, 16:9, 1.85:1, 2.35:1, 4:3, 3:2
	Underscan	OFF, ON
	Check Field	OFF, Mono, Red, Green, Blue
	Zoom	x1.5, x 2, x 3, x 4
	Freeze	OFF, ON
	DSLR	OFF, 5D2, 5D3

- Zoom

The image can be enlarged by ( x1.5, x 2, x 3, x 4) ratios. To select the "zoom" under Scan, choose the times under Zoom option which underneath the Check Field option.