



# Rack Mount Monitor

Rack mount monitor for broadcast & live streaming.  
Application for video wall & broadcast trucks.



## CONTENTS

1. FEATURES: .....	3
2. PRODUCT DESCRIPTION .....	4
2-1 Front Button/ Interface .....	4
2-2 Back Interface.....	2
3. MENU SETTING.....	3
3-1. Key Function:.....	3
3-1-1. The Image Menu .....	3
3-1-2. FN Function Buttons: .....	3
3-2. MENU Operation.....	4
3-2-1 Picture .....	4
3-2-2 Marker .....	9
3-2-3 Function.....	10
3-2-4 Waveform.....	12
3-2-5 Audio.....	16
3-2-6 System .....	17
4. ACCESSORIES .....	21
5. PARAMETERS .....	20
6. TROUBLE SHOOTING .....	22
7. 3D LUT Loading Demo.....	23
7-1. Format Requirement .....	23
7-2. LUT Format conversion.....	23
7-3. USB Loading.....	25

## IMPORTANT SAFETY INSTRUCTIONS:

- Please read User Guide before using this product.
- Please keep User Guide for future reference.
- Please read the cautions to prevent possible danger and loss of property.

## CAUTIONS:

- Please do not place the display screen towards the ground.
- Please avoid heavy impact or drop onto the ground.
- Please do NOT use chemical solutions to clean this product. Please wipe with a clean soft cloth to maintain the brightness of the surface.
- Please do not block any vent hole.
- Please follow the instructions and trouble-shootings to adjust the product. Other improper adjustment may result in damage. Any further adjustment must be performed or conducted by a qualified technician.

## 1. FEATURES:

- Support HDMI 2.0, 3G-SDI input and output.
- The output loop signal can support up to 4K.
- Support custom multiple waveform modes
- HDR function supports off/ST2084 300/ST 2084 1000/ST 2084 10000/HLG.
- Gamma range: 1.8-2.8.
- Support custom 3D-LUT loading.
- Support wide color gamut Native, SMPTE-C, Rec709, EBU, original.
- Comparison mode: can import color space, HDR/Gamma, camera Log to the right image.
- Support multiple color temperature modes: 6500K, 7500K, 9300K and user-defined.
- False-color (default, Spectrum, ARRI, RED).
- Aspect mark (16:9, 1.85:1, 2.35:1, 4:3, 3:2, 1.3X, 1.5X, 2.0X, 2.0X MAG).
- Aspect Display (Full, 16:9, 1.85:1, 2.35:1, 4:3, 3:2, 1.3X, 1.5X, 2.0X, 2.0X MAG).
- Audio: Support Audio level meter, HDMI supports 8 channels.
- Time code (LTC, VITC).
- Color bar mode (100%, 75%, Off).
- Marker Color (red, green, blue, black and white).
- Peaking Color: Red, Green, Blue, White, and Black are optional.

## 2. PRODUCT DESCRIPTION

### 2-1 Front Button/ Interface

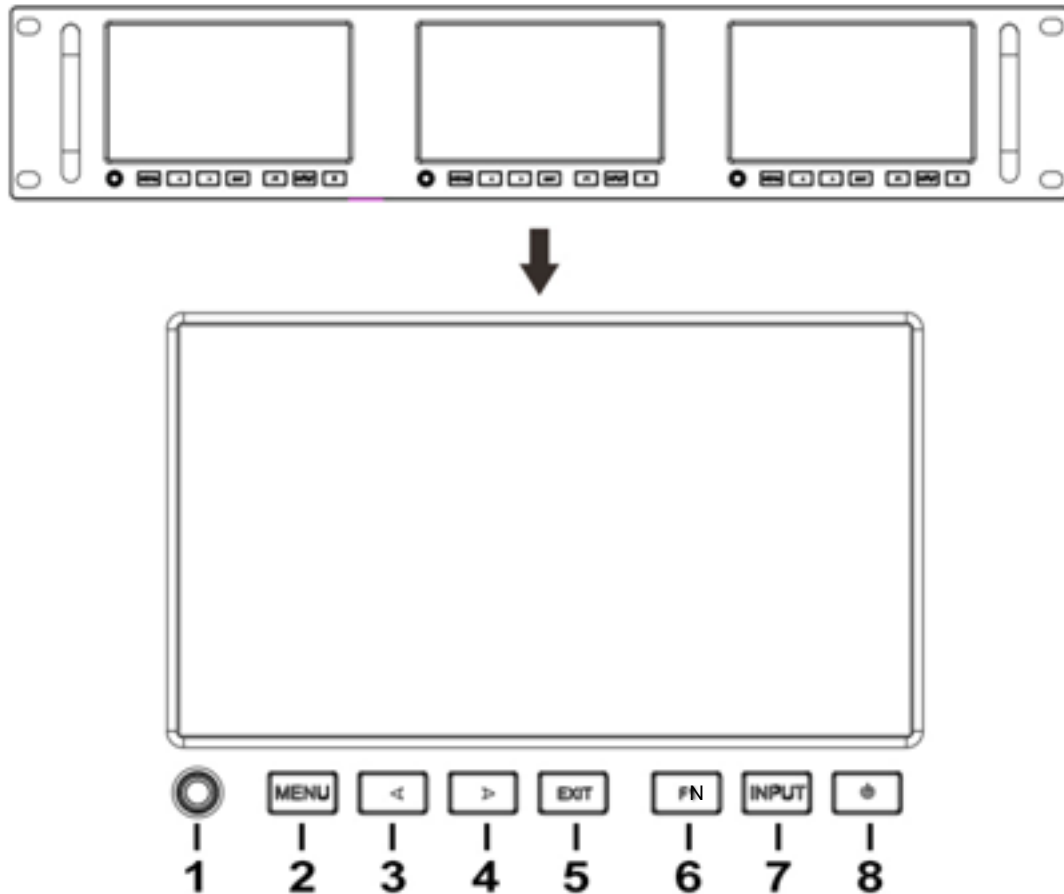

1. Earphone jack

2. Menu key: When the screen is on, press the MENU key to display the menu interface on the screen.

Option key: In the menu interface, use the left and right keys to select the desired menu option or option value.

Confirm key: After selecting the desired option, press the MENU key to confirm the option.

3. <: left Button.

4. >: Right Button.

5. IN/EXIT: return button for menu, long press to switch INPUT signal.
6. FN Shortcut Key.
7. SDI/HDMI input/ output interface.
8. Power Button.

## 2-2 Back Interface

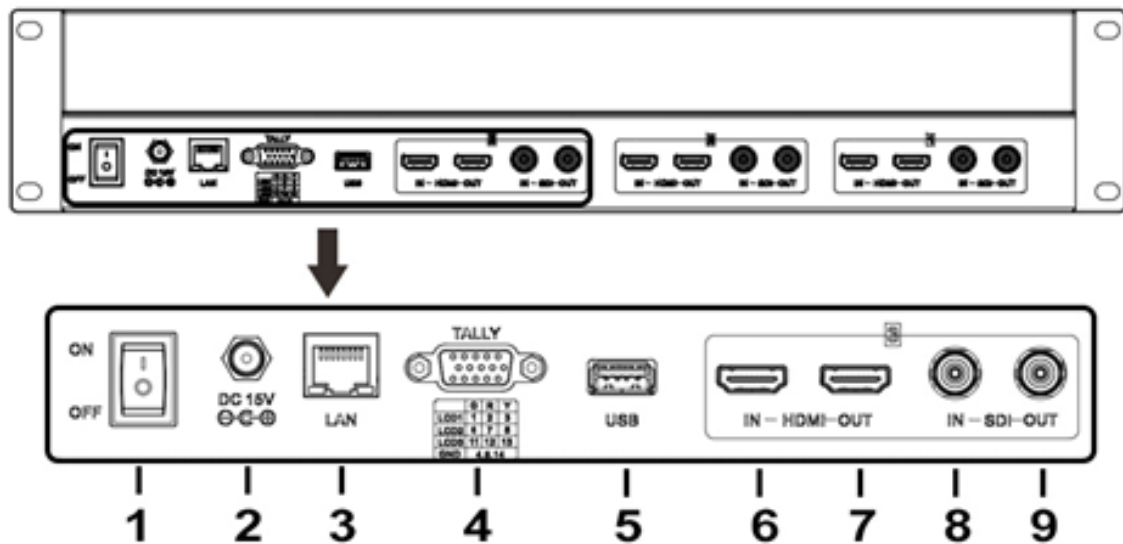

1. Battery plate switch.
2. DC 15V power input
3. LAN interface
4. TALLY interface
5. USB interface
6. HDMI input/output interface
7. SDI input/output interface.

### 3. MENU SETTING

Before setting the functions, please make sure the device is connected correctly.

#### 3-1. Key Function:

##### 3-1-1. The Image Menu

- Turn on the power, press the Menu button to display the menu, use the < or > button to switch between Picture, marker, function, waveform, audio, and system options in sequence.
- After selecting the option, press the Menu button to select it, use the < or > button to switch between values and options, and press the Menu button or Exit button again to confirm the change.
- Customizable < or > button functions, optional customization options: brightness, contrast, color, sharpness, volume, backlight, auxiliary focus level. After turning on the power, first press the < or > button to enter the volume customization option. At this time, press the Menu button to display the customization function options, which can be set according to your needs. Default: volume.

##### 3-1-2. FN Function Buttons:

Center Marker	Exposure
Aspect Marker	Histogram
Safety Marker	Full Mode
Overscan	Waveform
Scan	Vector
Aspect	TimeCode
HDR	Mute
Color Space	Level Meter
Gamma	
Camera Log	
Check Field	
H/V Delay	
Freeze	
Color Bar	
Peaking	
False Color	

- Long press the Fn button for 3-5 seconds, the shortcut menu settings will pop up. The display is shown on the right. Use the < or > button to select the option, press the Menu button to confirm the option, and set the option as a shortcut button option. Press Exit to exit the shortcut menu

interface.

- Users can set shortcut keys according to personal needs: center marker, Aspect marker, safety marker, Overscan, scan, Aspect, HDR, color Space, Camera, Camera Log, Check Field, H/V Delay, Freeze, Color Bar, Peaking False Color, Exposure, Histogram, Full Mode, Waveform, Vector, Time Code, Mute, Level Meter.
- The default shortcut function is: Peaking.

### 3-2. MENU Operation

- When power on, press “MENU” on the device. The menu of function setting will display on the screen.
- Press < or > button to choose menu, and press menu button to confirm, and then press EXIT to return.

#### 3-2-1 Picture

PICTURE		
	Brightness	50
	Contrast	50
	Saturation	50
	Tint	50
	Sharpness	0
	Color Space	Rec709
	Camera Log	Off
	Def. Log	SLog2ToLC-709
	SDI	1080p60Hz

PICTURE		
	Brightness	50
	Contrast	50
	Saturation	50
	Tint	50
	Sharpness	0
	RGB Range	Limited
	HDMI EDID	4K
	Color Space	Rec709
	HDMI	1080p25Hz

PICTURE		
	Color Space	Rec709
	Camera Log	Off
	Def. Log	SLog2ToLC-709
	User Log	No Data
	Gamma	2.2
	Back Light	100
	HDR	Off
	Color Temp.	6500K
	SDI	1080p60Hz

PICTURE		
	Color Space	Rec709
	Camera Log	Off
	Def. Log	SLog2ToLC-709
	User Log	No Data
	Gamma	2.2
	Back Light	100
	HDR	Off
	Color Temp.	6500K
	HDMI	1080p60Hz



ITEMS	OPTIONS
Brightness	0 – 100
Contrast	0 – 100
Saturation	0 – 100
Sharpness	0 – 100
RGB Range	Full/Limited
HDMI EDID	4K/2K
Color Space	Native, SMPTE-C, Rec709, EBU
Camera Log	Off、 Default、 User
Def. Log	SLog2ToLC-709, SLog2ToLC-709TA, SLog2ToSLog2-709, SLog2ToCine+709, SLog3ToLC-709, SLog3ToLC-709TA, SLog3ToSLog2-709, SLog3ToCine+709, ArriLogCto709, ArriLogCtoP3DCI, CLogTo709, VLogToV709, JLogTo709, JLogTo709HLG, JLogTo709PQ, Z7 NLogTo709,

	D780 NLogTo709, (Only when HDR Off)		
User Log	No Data (User1~User6)		
Gamma	Off, 1.8, 2.0, 2.2, 2.35, 2.4, 2.6, 2.8 (Only when HDR Off)		
Back Light	0~100		
HDR	Off, ST 2084 300, ST 2084 1000, ST 2084 10000,HLG		
Color Temp	6500K/7500K/9300K/User		
	Red Gain	0-128-255	Note: Available only under "User" mode to choose the color value you need.
	Green Gain	0-128-255	
	Blue Gain	0-128-255	
	Red Offset	0-256-511	
	Green Offset	0-256-511	
	Blue Offset	0-256-511	

- **Brightness**

Adjust the general brightness of the LCD from [0]-[100]. For example, if the user is outside in bright conditions, increase the LCD brightness to make it easier to view.

- **Contrast**

Increases or decreases the range between the bright and dark areas of the image. High contrast can reveal detail and depth in the image, and low contrast can make the image appear soft and flat. It can be adjusted from [0]-[100].

- **Saturation**

Adjust the color intensity from [0]-[100]. Turn the knob right to increase the color intensity and turn left to decrease it.

- **Sharpness**

Increase or decrease the sharpness of the image. When the image sharpness is insufficient, increase the sharpness to make the image clearer. It can be adjusted from [0]-[100].

- **Back light**

Increase or decrease the backlight of the Monitor. It can be adjusted from [0]-[100].

- **Color Space**

Select the display gamut from among [Native], [SMPTE-C], [Rec709], [EBU].

- **Camera log**

Default Log: Defaults log got 17 Log modes, which can be switched according to the following sequence:

SLog2ToLC-709,SLog2ToLC-709TA,SLog2ToSLog2-709,SLog2ToCine+709,SLog3ToLC-709,SLog3ToLC-709TA,SLog3ToSLog2-709,SLog3ToCine+709,ArriLogCto709,ArriLogCtoP3DCI,CLogTo709,VLogTo709,JLogTo709,JLogTo709HLG,JLogTo709PQ,Z7 NLogTo709,D780 NLogTo709,



- **User log:** 6 modes can be customized, please follow the steps below to load: Please name the file to be loaded with the suffix .cube. Please note: only supports 17x17x17/33x33x33 format, the data format and table format are BGR documents, if the document format is incorrect, please use the tool "Lut Tool.exe" to convert. The default document is named. User1-User6.cube file. Load the document into the USB flash drive.
- **Loading steps:** Turn on the machine-insert the U disk. When loading the machine for the first time, it will automatically load the relevant documents into the user log. If the document is not loaded for the first time, the machine will pop up an interface prompt. Please choose whether to update or not according to the prompt.

- **Gamma**

Use this setting to choose one of the Gamma tables:

[Off], [1.8], [2.0], [2.2], [2.35], [2.4], [2.6], [2.8].

Gamma correction represents the relationship between the pixel levels from the incoming video and the luminance of the monitor. The Lowest gamma level available is 1.8, will cause the image to appear brighter. The highest gamma level available is 2.8, will cause the image to appear darker.

**Note!** Gamma mode can be **ONLY** activated while HDR function closed.



Gamma 1.8

Gamma 2.8

- **HDR**

Use this setting to choose one of the HDR presets:

[Off], [ST 2084 300], [ST 2084 1000], [ST 2084 10000], [HLG].

When HDR is activated, the display reproduces a greater dynamic range of luminosity, allowing lighter and darker details to be displayed more clearly. Effectively enhancing the overall picture quality.

HDR OFF

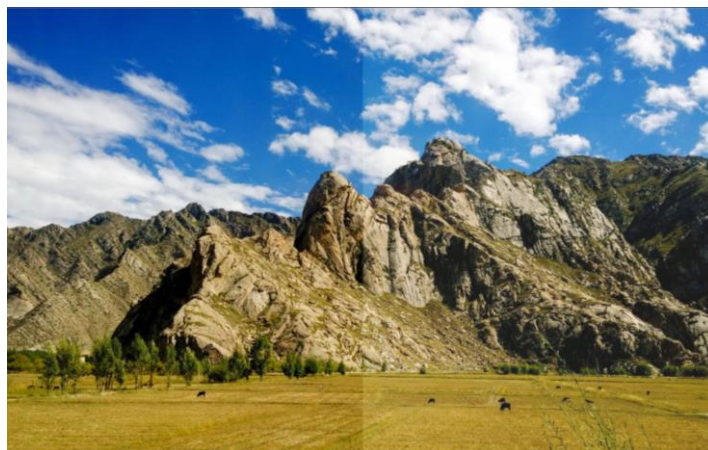

HDR ON

- **Color Temp**

[6500K], [7500K], [9300K] and [User] mode for optional.

Adjust the color temperature to make the image warmer (Yellow) or colder (Blue). Increase the value to make the image be warmer, decrease the value to make the image be colder. User can use

this function to strengthen, weaken or balance the image color according requirements. The standard white light color temperature is 6500K.

Color Gain/Offset is available only under "User" mode to choose the color value.

- SDI (or HDMI) -

Representing the source that is currently being displayed on the monitor. It is unable to choose and change the source from OSD.

### 3-2-2 Marker



ITEMS	OPTIONS
Center Marker	OFF, ON
Aspect Marker	OFF, 16:9, 1.85:1, 2.35:1, 4:3, 3:2, 1.3x, 1.5x, 2.0X, 2.0X Mag,
Safety Marker	OFF, 95%, 93%, 90%, 88%, 85%, 80%
Marker Color	Red, Green, Blue, White, Black
Aspect Mat	OFF, 1– 7
Thickness	OFF, 1– 7

- **Center marker:**

Select On, it will appear "+" marker on center of screen.



● **Aspect ratio:**

The Aspect Marker provides various aspect ratios, as the following:

[OFF], [16:9], [1.85:1], [2.35:1], [4:3], [3:2], [1.3X], [2.0X], [2.0X MAG].







● **Aspect ratio:**

Used to select and control the size and availability of the safety area. Available type are [OFF], [95%], [93%], [90%], [88%], [85%], [80%] preset to choose.

● **Marker color & Aspect mat & Thickness:**

Marker Mat darkens the area of the outside of Marker. The degrees of darkness are between [0] to [7]. Marker Color controls the color of the marker lines and the thickness controls the thickness of the marker lines.

**3-2-3 Function**

FUNCTION		
	Scan	Aspect
	Aspect	Full
	Overscan	Off
	H/V Delay	Off
	Check Field	Off
	Zoom	50%
	Freeze	Off
	HDMI	1080p25Hz

ITEMS	OPTIONS
Scan	Aspect, Pixel To Pixel, Zoom

	(Options can be adjusted only under scan mode.)
Aspect	Full, 16:9, 1.85:1, 2.35:1, 4:3, 3:2, 1.3X, 1.5X, 2.0X, 2.0X MAG
Overscan	OFF, ON
H/V Delay	OFF, H, V, H/V
Check Field	OFF, Red, Green, Blue, Mono
Zoom	10%-90%
Freeze	Off/On

● **Scan:**

Use this menu option to choose Scan mode. There are three modes preset: Zoom, Aspect, Pixel To Pixel.

● **Aspect:**

Select Aspect under Scan option, then use Aspect option to switch between several aspect ratio setting. For example:

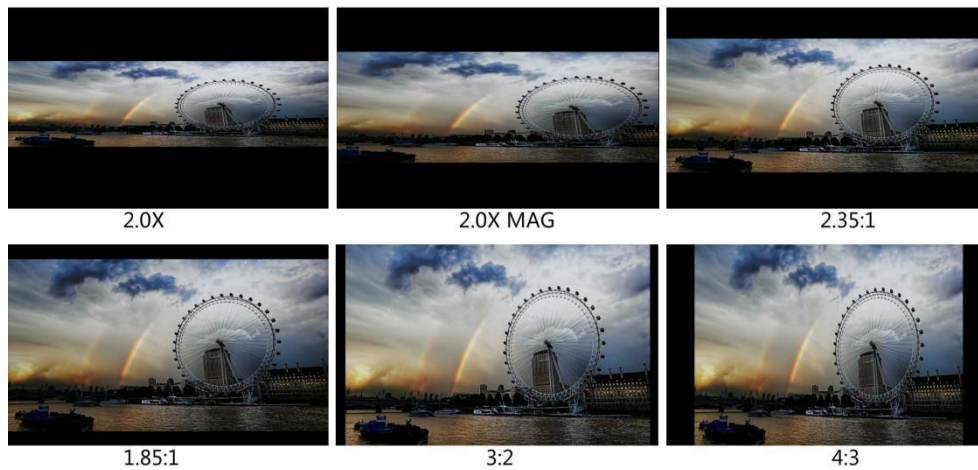

● **Overscan:**

Use this item to activate or deactivate overscan.

● **H/V Delay:**

Select one of the H/V modes: [OFF], [H], [V], [H/V]. When H/V Delay on, the blanking portions of the input signal will be displayed horizontally and vertically.

- **Check Field:**

Use the check field modes for monitor calibration or to analyze individual color components of an image. In [Mono] mode, all color is disabled and only a grayscale image is shown. In [Blue], [Green], and [Red] check field modes, only the selected color will be shown.

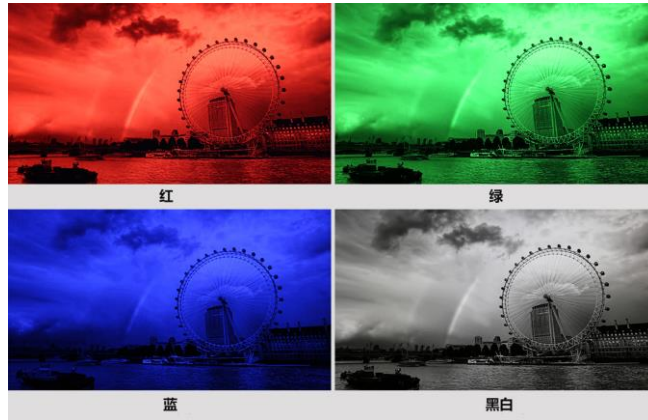

- **Zoom:**

The image can be enlarged by [X1.5], [X2], [X3], [X4] ratios. To select the [Zoom] under [Scan], choose the times under [Zoom] option which underneath the Check Field option.

**Note!** Zoom option can **ONLY** be activated as user select [Zoom] mode under [Scan].

- **Freeze:**

Choose [On] to capture one frame of current image on the screen, and choose [Off] to close freeze function.

### 3-2-4 Waveform

WAVEFORM		
	Full Mode	Off
	Waveform	RGB
	Vector	On
	Transparency	50%
	Peaking	Off
	Peaking Color	Red
	Peaking Level	50
	False Color	Off
	SDI	1080p60Hz

WAVEFORM		
	Peaking Color	Red
	Peaking Level	50
	False Color	Off
	False Color Table	On
	Exposure	Off
	Exposure Level	100IRE
	Histogram	Y
	TimeCode	LTC
	SDI	1080p60Hz



ITEMS	OPTIONS
Full Mode	OFF, Y, YCbCr, RGB, Vector, Histogram, Audio
Waveform	OFF, Y, YCbCr, RGB
Vector	On, OFF
Transparency	OFF, 25%, 50%
Peaking	OFF
Peaking Color	Red, Green, Blue, White, Black
Peaking Level	0 – 100
False Color	OFF, ON(Default, Spectrum, ARRI, RED)
False Color Table	OFF, ON
Exposure	OFF, ON
Exposure Level	50-100IRE
Histogram	OFF, Y, RGB, Color
Time Code	OFF, LTC, VITC (available under SDI mode only.)

● **Waveform:**

- Use this item to activate or deactivate Waveform. Select the waveform mode from among [Y], [YCbCr], [RGB].
- [Y]: Display Y Waveform.
- [YCbCr]: Display YCbCr Waveform.
- [RGB]: Display R/G/B Waveform.

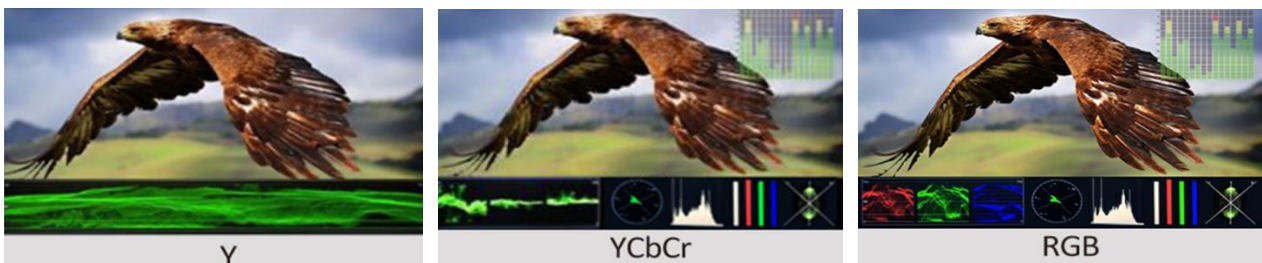

● **Vector:**

Use this item to activate or deactivate Vector.

- **Transparency:**

Adjustment of transparency can support waveform, vector, histogram, audio vector, level meter. Transparency can be selected from among [off], [25%], and [50%].

- [Off] : The background of waveform is shown at black.
- [25%]: The background of waveform is shown at 25% intensity.
- [50%]: The background of waveform is shown at 50% intensity.

- **Peaking:**

Use this item to activate or deactivate the peaking function.



- **Peaking color:**

Select one of the peaking colors: [Red], [Green], [Blue], [White], [Black].

- **False Color:**

Use this item to activate or deactivate the false color function.

When activated, [Off], [Default], [Spectrum], [ARRI], [RED] are for optional.

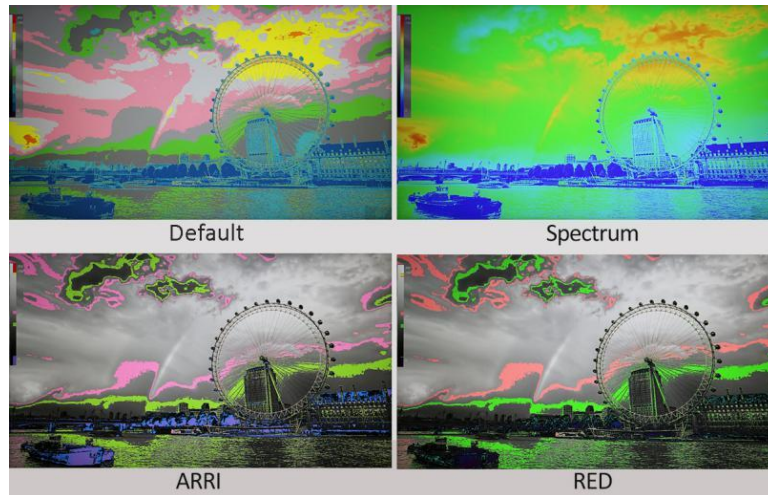

- **False Color Table:**

Use this item to activate or deactivate the false color table. The range of the false color table is between 0-100 IRE.

- **Exposure & Exposure Level:**

The exposure feature helps the user achieve optimum exposure by displaying diagonal lines over areas of the image that exceed the setting exposure level. The exposure level can be set to [50]-[100].

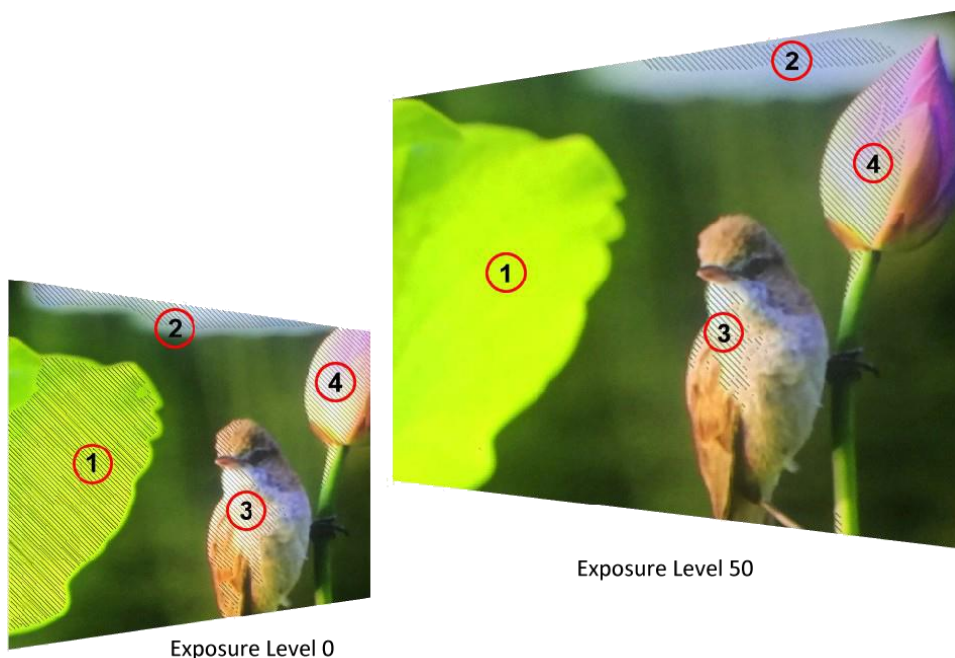

- **Histogram:**

Use this item to activate or deactivate histogram. When activated, [Y], [RGB], [Color] are for

optional.

- [Y]: Display Y histogram.
- [RGB]: Display RGB mixed histogram.
- [Color], Display RGB separated histogram.

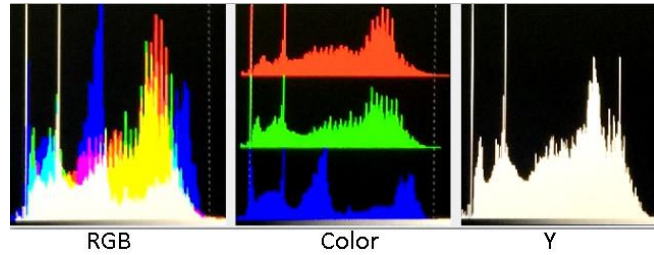

● Time Code:

Use this item to activate or deactivate the Time Code. When activated, [Off], [LTC], [VITC] are for optional.

**Note:** Time code is only available under SDI mode.

3-2-5 Audio

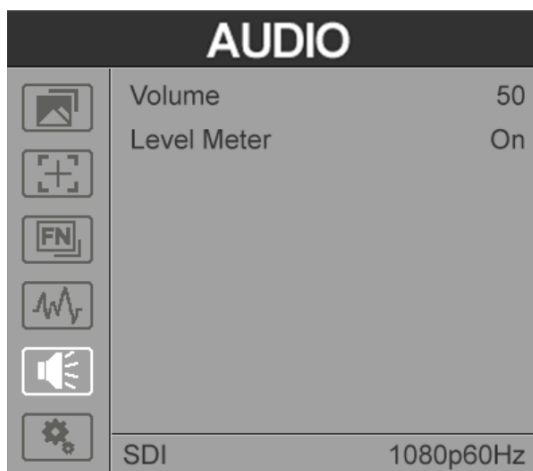

ITEMS	OPTIONS
Volume	0 – 100
Level Meter	OFF, ON (default as on under waveform multi function.)
Audio channel	CH1-8 (available under HDMI mode only).

● Volume

To adjust the volume from [0]-[100] for the built in speaker and earphone jack audio signal.

● Level Meter

Select whether to activate or deactivate level meter.

**Note:** Default as on under [Waveform]-[Multi] function.

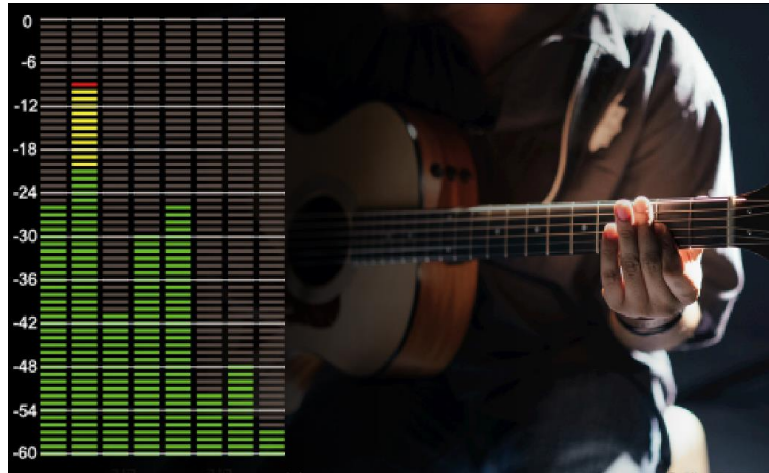

● Audio channel

Select audio channel.

3-2-6 System

SYSTEM		
	Language	English
	Color Bar	Off
	OSD Timer	10s
	OSD H Position	50
	OSD V Position	50
	Color Calibration	Off
	Comparison En	Off
	DHCP	Off
	HDMI	1080p25Hz

SYSTEM		
	OSD V Position	50
	Color Calibration	Off
	Comparison En	Off
	DHCP	On
	IP Address	0 . 0 . 0 . 0
	Sub. Mask	0 . 0 . 0 . 0
	Gateway	0 . 0 . 0 . 0
	Reset	Off
	HDMI	1080p25Hz

ITEMS	OPTIONS
Language	English, Chinese
Color Bar	OFF, 100%, 75%

OSD Time	10s, 20s, 30s
OSD H Position	Choose between 0-100, Default: 50
OSD V Position	Choose between 0-100, Default: 50
Color Calibration	OFF,ON
Comparision En	OFF,ON
DHCP	OFF,ON
IP Address	0.0.0.0
Sub.Mask	0.0.0.0
Gateway	0.0.0.0
Reset	OFF,ON

### Language

Switch between [English] and [Chinese].

- **Color Bar**

Turn on/off color bar. When the color bar on, it can be selected: [OFF], [100%], [75%].

- **OSD Time**

Select the displaying time of the OSD. It has [10s], [20s], [30s] preset to choose. Default: 10s.

- **OSD H/V Position**

Option: 0-100. Default: 50.

- **Color Calibration**

Select [On] or [Off].

If the device needs to be calibrated color, please operate as following:

Connect the device with the PC via HDMI interface.

Make sure the device and color calibration equipment to work more than 30 minutes.

After the previous step, activate the Color Calibration function of the device and color calibration software to calibrate the color (See the document "CMS Color Calibration Process" for details).

It will generate a document "Rec709.cube" after calibrated, then copy this document to USB flash

disk.

Insert the USB flash disk to the device and save the document. This document "Rec709.cube" will be found under Color Space Option.

### ● Comparison

Use this setting to activate or deactivate the Comparison En function.

When activated, the screen displays the comparison of Original image and customized image, as shown.



Option: [Off], [Gamma/HDR], [Color Space], [Camera Log]. Default: [Off].

### ● Reset

If there is any problem unknown, press to confirm after selected. The monitor will return to default settings.

### ● DHCP

- [On]: The monitor will automatically get an IP address from network for remote control via various programs.

- [Off]: Manually configure IP address.

### ● IP Address

Manually configure IP address: xxx.xxx.xxx.xxx

*Note: When [DHCP] on, IP address cannot be manually set.*

### ● Sub net Mask

Manually configure Sub net Mask: xxx.xxx.xxx.xxx

Note: When [DHCP] on, Sub net Mask cannot be manually set .

- Gateway

Manually configure Gateway: xxx.xxx.xxx.xxx

Note: When [DHCP] on, Gateway cannot be manually set .

If there is any problem unknown, press to confirm after selected. The monitor will return to default settings.

## 5. PARAMETERS

Panel	3x5"
Aspect Ratio	16:9
Physical Resolution	1920×1080
Brightness	450 cd/m <sup>2</sup>
Contrast	1000:1
Viewing Angle	160°/ 160°(H/V)
Color Space	98% DCI-P3
LUT Support	3D-LUT(.cube format)
Input Signal	3G-SDI, HDMI 2.0.
Output Signal	3G-SDI, HDMI 2.0.
Current	2.5A(12V)
Input Voltage	DC 7-24V
Power Consumption	≤27W
Operating Temperature	-0°C ~50°C
Storage Temperature	-20°C ~60°C
Dimension (LWD)	480×116×88mm
Weight	2.1kg



## 5. ACCESSORIES



### Standard:

- |                      |       |
|----------------------|-------|
| 1. 15V/2A DC adapter | 1 pc. |
| 2. Tally adaptor     | 1 pc. |
| 3. User Manual       | 1 pc. |

## 6. TROUBLE SHOOTING

### 1. Only black-and-white display:

Check whether the color saturation is properly setup or not.

### 2. Power on but no pictures:

Check whether the cables of 3G-SDI and HDMI are correctly connected or not. Please use the standard power adapter coming with the product package. Improper power input may cause damage.

### 3. Wrong or abnormal colors:

Check whether the cables are correctly and properly connected or not. Broken or loose pins of the cables may cause a bad connection.

### 4. When on the picture shows size error:

Press "MENU → FUNCTION → Underscan" to zoom in/out pictures automatically when receiving HDMI signals

### 5. Other problems:

Please press "MENU" button and choose "MENU→SYSTEM→ Reset →ON"

### 6. According to the ISP, the machine can not function properly:

ISP for program upgrades, non-professionals do not use. Please reboot your device if press accidentally!

**Note:** due to constant effort to improve products and product features, specifications may change without notice.

## 7. 3D LUT Loading Demo

### 7-1. Format Requirement

- LUT format

Type: .cube

3D Size: 17x17x17

Data Order: BGR

Table Order: BGR

- USB flash disk version

USB: 2.0

System: FAT32

Size: <16G

- Color calibration document: lcd.cube

- User Log: User1.cube ~User6.cube

### 7-2. LUT Format conversion

The format of LUT should be transformed if it doesn't meet monitor's requirement. It can be transformed by using Lut Converter (V1.3.30).

#### 7-2-1. Activate Lut converter

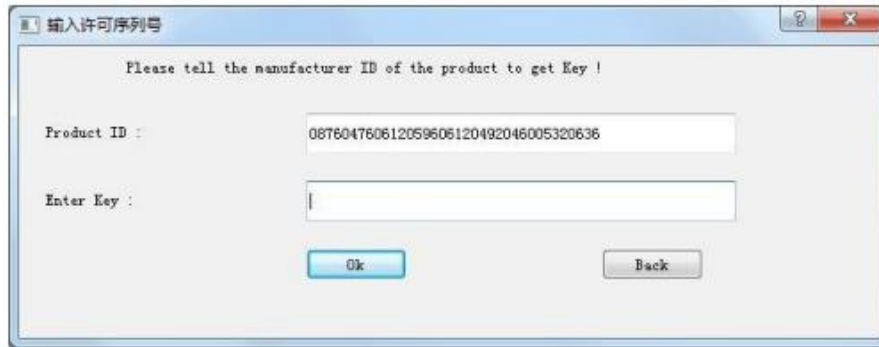

One individual Product ID for one computer. Please send the ID number to Sales to get an Enter Key.

Then the computer gets the permission of the Lut Tool after input the Enter Key.

7-2-2. Enter the Lut Converter interface after input the Enter Key.

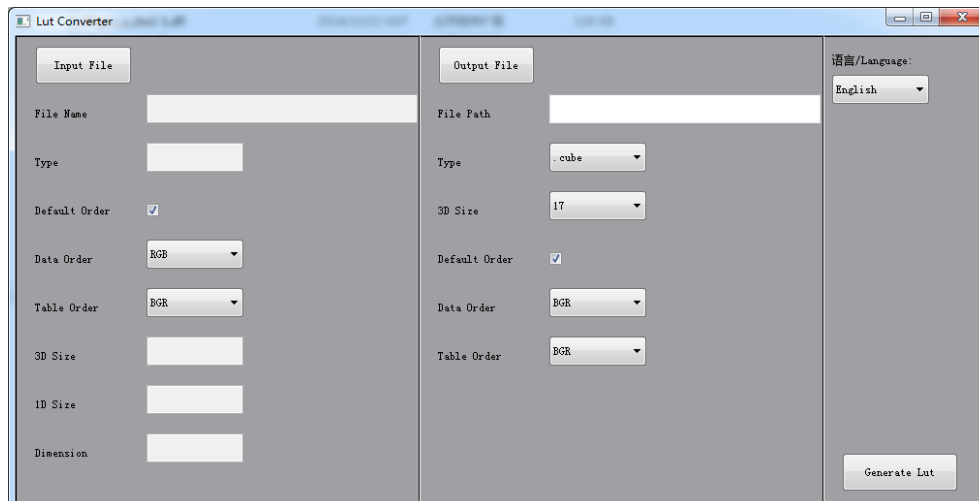

7-2-3. Click Input File, then select \*LUT.

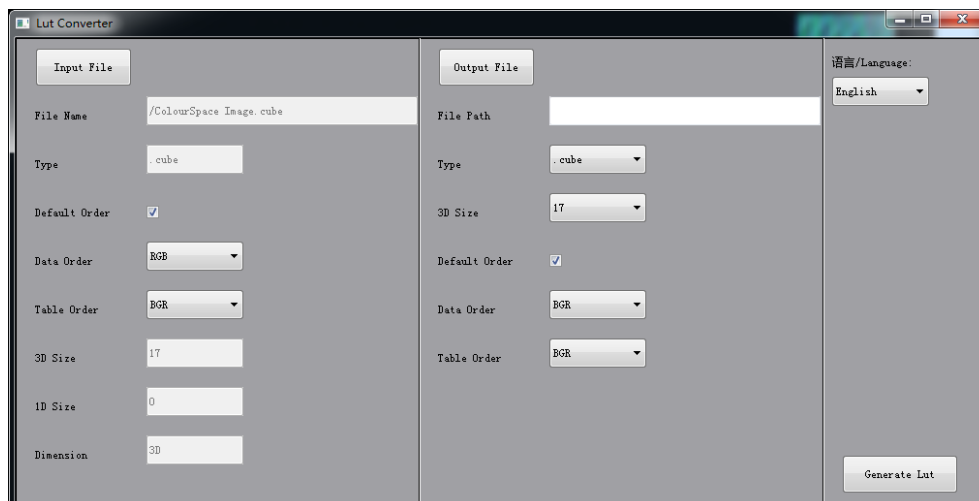

7-2-4. Click Output File, choose the file name.

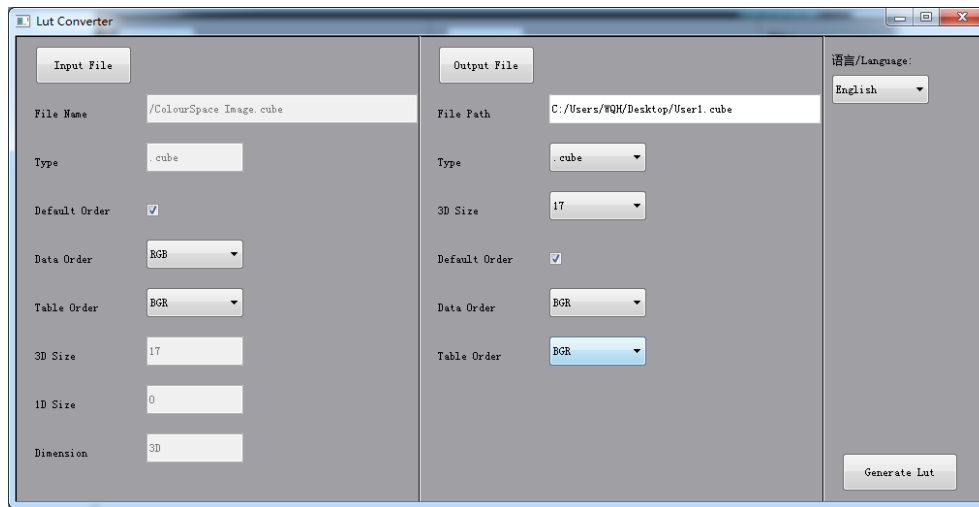

7-2-5. Click Generate Lut button to finish.

### 7-3. USB Loading

Copy the needed files to the root directory of the USB flash disk.

**Note!** LUT files after conversion must be named "User1", "User2", "User3", "User4", "User5" or "User6".

Plug the USB flash disk into USB port of the device after power on. Click "Yes" on the pop-up prompt

window (If the device doesn't pop-up the prompt window, please check if the LUT document name or the USB flash disk version meets monitor's requirement.), then press Menu button to update automatically. It will pop-up a prompt message if the update completed.