

GUDSEN



MOZA AirCross

User Manual

www.gudsen.com

Contents

1. Instruction	II
2.Package List	01
3.Getting to know about Moza AirCross	04
4.Getting Start	05
5.Gimbal Control	10
6. Firmware update	11
7. App Installation	18
8. Mobile App Instruction	19
9. Wireless Thumb Controller	26
10. Mimic Motion Control	33
11. Specifications	35
12. Warranty	36
13. FAQ& Customer Support	37
14.Index.....	38

Instruction

Thank you for choosing Gudsen. The Moza AirCross is a professional handheld gimbal designed to create and capture cinematic camera movement. The Moza AirCross can support all mirrorless cameras. The Moza AirCross features advanced motor control technology, high-quality materials, and industry leading software.

By using this product, you hereby signify that you have read this document carefully and that you understand and agree to abide by the terms and conditions herein. You agree that you are solely responsible for your own conduct while using this product. You agree to use this product only for purpose that are proper and in accordance with all terms, precautions, practices, policies, and guidelines Gudsen has made and may make available.

Gudsen reserves the right of final explanation for this document and all relevant documents relating to Moza AirCross, and the right to make changes at any time without notice.

Package list

Gimbal X 1

Moza AirCross Gimbal.

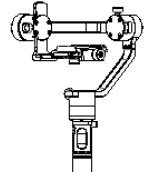

Handgrip X 1

Main handle of the Moza AirCross, battery holder.



Moza Modified Batteries X 3

Moza modified batteries.



Charger X 1

Moza modified battery charger.

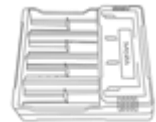

Tripod X 1

The base of Moza AirCross gimbal.



Wireless thumb controller (Optional) X 1

Wireless thumb controller.



Lens support X 1

Holder of camera lens.

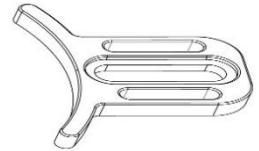

Lens Support Screw X 1

To secure the camera lens holder.



Handle Bar (Optional) X 1

Dual-hand grip accessories.



Side Handle (Optional) X 2

Dual-hand grip accessories.



Control cable X 2

- ① Panasonic Control Cable
- ② Sony Control Cable

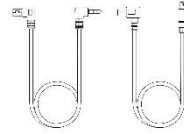

USB cable X 1

For firmware update or modification of parameters.

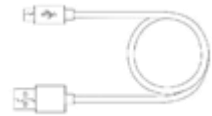

Tool Bag X 1

Carrier of the accessories

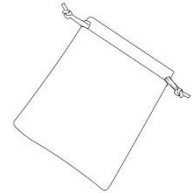

User Manual X 1

Instruction



Anker convertor X 1

Anker convertor



Getting to know about Moza AirCross

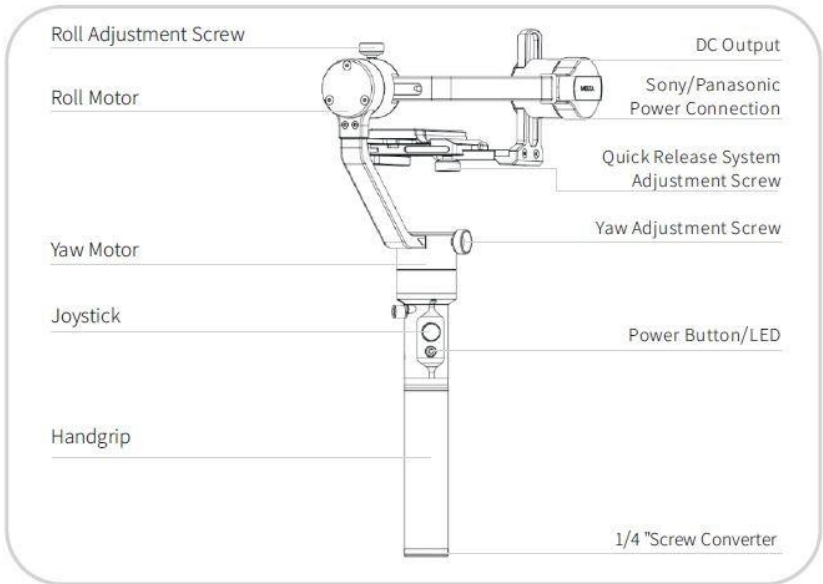
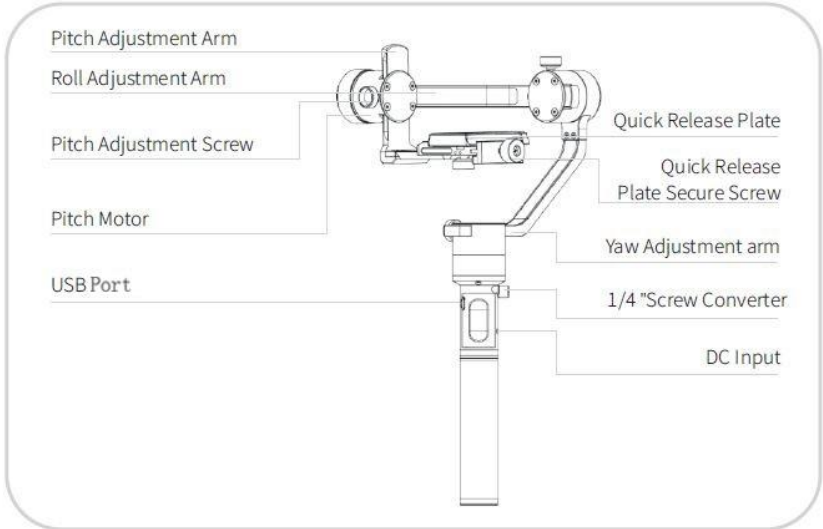

Getting Started

Battery Installation

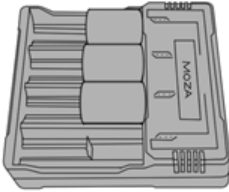

Please charge the batteries with the MOZA charger before using the Moza AirCross.

Battery Safety Guidelines

WARNING

To avoid fire, serious injury, and property damage, observe the following safety guidelines when using, charging, or storing your batteries.

Battery Use

1. Do not let the batteries to come into contact with any kind of liquid. DO NOT leave batteries out in the rain or near a source of moisture. DO NOT drop the battery into water. If the inside of the battery comes into contact with water, chemical decomposition may occur, potentially resulting in the battery catching on fire, and may even lead to an explosion.
2. If the battery falls in to water by accident, put it in a safe and open area immediately. Maintain a safe distance from the battery until it is completely dry. Never use the battery again, and dispose of the battery properly as described in the Battery Disposal section below.
3. Do not extinguish any battery fire using water, sand, fire blanket or a dry powder fire extinguisher.
4. Never use non-MOZA modified batteries. If replacement or backup is needed, please purchase new batteries from <http://www.gudsen.com>.
5. Never use or charge swollen, leaky, or damaged batteries. If your batteries are abnormal, contact Gudsen technical support or Gudsen authorized vendor for further assistance.
6. The battery should be used in temperatures from 0-40°C. Use of the battery in environments above 40°C can lead to a fire or explosion. Use of battery below 0 °C can lead to permanent damage.
7. DO NOT use the battery in strong electrostatic environments. Otherwise, the battery control board may malfunction.
8. Never disassemble or pierce the battery in any way or the battery may leak, catch fire, or explode.
9. DO NOT drop or strike batteries. DO NOT place heavy objects on the batteries or charger.
10. Electrolytes in the battery are highly corrosive. If any electrolytes make contact with your skin or eyes, immediately wash the affected area with fresh running water for at least 15 minutes, and then go to a doctor immediately.
11. DO NOT use the battery if it received impact from a fall or other accidents.
12. DO NOT heat batteries. DO NOT put batteries in a microwave oven or in a pressurized container.
13. DO NOT place loose battery cells on any conductive surface, such as a metal table.
14. DO NOT manually short-circuit the battery.
15. Clean battery terminals with a clean, dry cloth.

Battery Charging

1. DO NOT attach the batteries to wall outlets or car charger sockets directly, always use a MOZA

official charger. Gudden takes no responsibility if the battery is charged using a non-MOZA official charger,

2.Never leave the battery unattended during charging. DO NOT charge the battery near flammable materials or on flammable surfaces such as carpet or wood.

3.DO NOT charge the battery immediately after use, because the battery temperature may be too high. Wait to charge the battery until it cools down to near room temperature. Charging the battery outside of the temperature range of 0-40°C may lead to leakage, overheating, or battery damage.

4.Disconnect the charger when not in use. Examine the charger regularly for damage to the cord, plug, enclosure, or other parts. DO NOT clean the charger with denatured alcohol or other flammable solvents. Never use a damaged charger.

Battery Storage

1.Keep batteries out of the reach of children and pets.

2.DO NOT leave the battery near heat sources such as a furnace or heater. DO NOT leave the batteries inside of a vehicle on hot days.

3.Always keep the battery in a dry place.

4.DO NOT store the battery fully discharged for long periods of time, otherwise it will over discharge and lead to permanent damage.

Battery Maintenance

1.Never use the battery when the temperature is too high or too low.

2.Never store the battery in environments with a temperature higher than 60°C.

Battery Disposal

Dispose of the battery in specific recycling boxes only after a complete discharge. DO NOT place the battery in regular trash containers. Strictly follow your local regulations regarding the disposal and recycling of batteries

Power Connection Installation

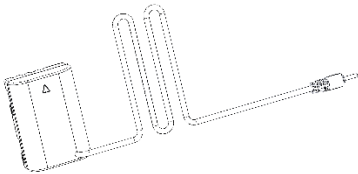

Panasonic Power Connection(Optional)

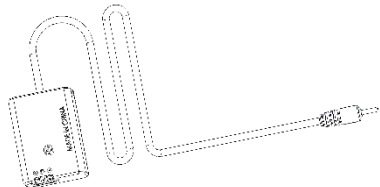

Sony Power Connection(Optional)

1.Turn off the camera and take out the camera battery.

2.Put Sony/Panasonic Power Connection into the camera battery compartments.

3.Pull out the DC cable from the Power Connection and plug it in the DC output on the Moza AirCross.

DC Input

MOZA AirCross can be powered through External Power Input, power supply cable is 3.5mm DC, external power supply voltage is 12V, electric current is not less than 2A, try the DC adapter with the sign as below:

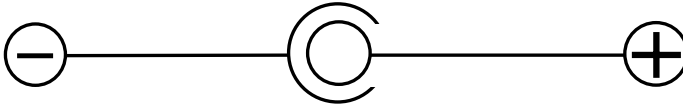

Mounting your camera

1. Please place the camera on the quick release plate, aim the 1/4" threaded hole at the bottom of the camera with the empty slot of the mounting plate.
2. then tighten the secure screw on the quick release system.

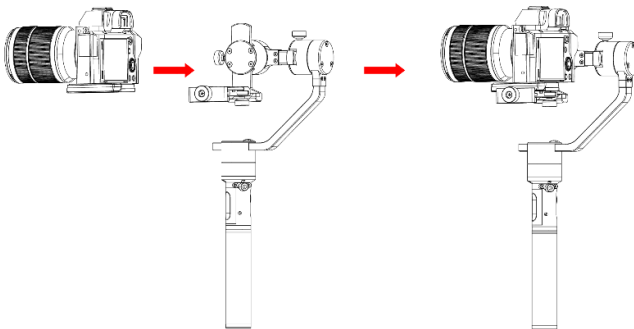

Balance the camera

1. Please move the camera forward and backward until you find a position where the lens face front and the camera can keep complete still.

2. Tighten the camera lock-knob.

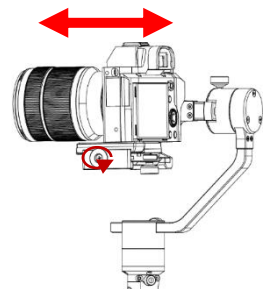

Balance the Tilt Adjustment Arm

1. Please loosen Tilt Adjustment Screw and adjust the Tilt Adjustment Arm until it remains still with the lens facing vertical or toward the ground.
2. Once balanced tighten the Tilt Adjustment Screw.

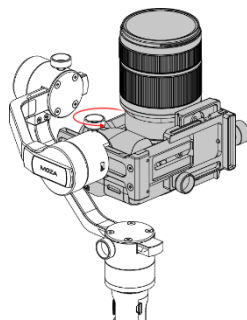

Balancing the Roll Adjustment Arm

1. Please loosen the quick Release system adjustment screw, be sure to leave a little space between the camera and the motor, in this case move the quick release plate to the till motor as possible as you can, then tighten the quick Release system adjustment screw.
2. Please loosen the Roll Adjustment Screw and adjust the Roll Adjustment Arm until the camera remains still and level with the horizon.
3. Once balanced tighten the Roll Adjustment Screw.

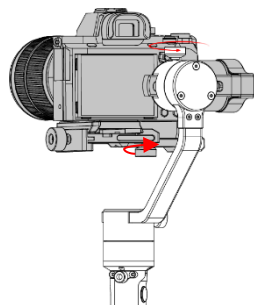

Balancing the Yaw Adjustment Arm

1. Please loosen the Yaw Adjustment Screw and adjust the Yaw Adjustment Arm until the camera remains still and level with the horizon.
2. Once balanced tighten the Yaw Adjustment Screw.

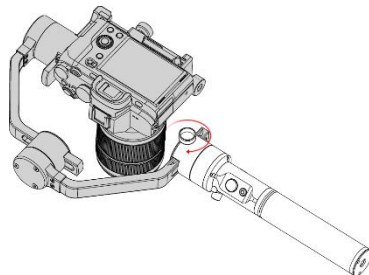

Dual handle Setup

Install the two Side Handles and secure them by screwing them into each side of the handle clamp. Loosen the lock-screw in the middle of the handle clamp. Then clamp onto the handgrip of the Moza AirCross, adjust desired position and secure the lock-screw.

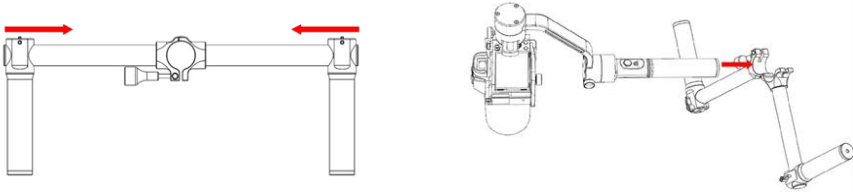

Camera Control Cables

Connect the camera to the Camera Connection (Mini-USB port) on the tilt motor with the control cable. Please make sure the cable doesn't affect the movement of the Moza AirCross. When finished, test by pressing the Power on/Off button on the Moza AirCross to start/stop the camera's recording. (Check page 20 to select the right camera profile.)

Shutter cable is required when operating the advanced time-lapse.

Sony control cable can be used as shutter cable on Sony camera with MULTI input. Other brand cameras shall purchase extra shuttle cable to enable the advanced time-lapse.

Model	Example	Recording	Recording control cable	Picture taking	Picture taking control cable
EOS DSLR	Canon 5D3, 60D	support	Canon control cable	support	C1 or C2 shutter cable
EOS Cinema					
Alpha	Sony A7s, A7s2	support	Sony control cable	support	Sony control cable or S1 shutter cable
GH	Panasonic GH3, GH4	support	Panasonic control cable	support	
BMD	BMPC, BMPCC	support	Panasonic control cable	Not Support	
NIKON	D4, D800			support	N1 or N3 shutter cable
OTHERS				support	Camera typical shutter cable

Moza AirCross Controls



Available operation modes

- 1.Yaw-follow mode: The Yaw Adjustment Arm follow the movement while the Tilt and Roll Adjustment Arm are locked.
- 2.Tilt - Yaw follow mode: The Tilt and Yaw Adjustment Arm follows the movement while the Roll Adjustment Arm is locked.
- 3.All lock mode: All three Adjustment Arm are locked.
- 4.Roll-follow mode: The Roll Arm Adjustment Arm follows the movement while the Tilt and Yaw Adjustment Arm are locked.

Joystick

- 1.One quick press: Yaw-follow mode.
- 2.Double quick press: Tilt-yaw follow mode.
- 3.Triple quick press: All-lock mode.
- 4.Four times quick press: Roll-follow mode.
- 5.Long press/quick press again: Enable sleeping mode/ wake up .
- 6.Normal turning on, then hold down the joystick while quick press the power button: Auto-Tune.
- 7.Normal turning on, then hold down the joystick while three times quick press the power button: Six direction calibration.

Power button

- 1.One quick press: Start/Stop recording.
- 2.Double quick press: Photo-taking.
- 3.Triple quick press: auto-center.
- 4.Four times press: Enable roll control.
- 5.Long press: Power on/off the Moza AirCross.

Firmware Update

This tutorial contains two parts:

Moza AirCross firmware update tutorial.

Wireless thumb controller firmware update tutorial.

Part1: Moza AirCross firmware update tutorial.

Notice:

Attention: All the firmware files are available on the server, Guksen has not released any Moza product firmware update packages on the network. The only access to do the update is upgrading via Moza Assistant software.

Step 1: Download Moza Assistant

Please download the Moza Assistant from here: <http://www.gudsen.com/moza-AirCross-downloads.html>, and select the proper software according to your computer operating system.

Download the software package and unzip the files and install the driver.

Please refer to the link below if your Mac computer reject the driver installation and get the error message like the picture suggested:

<http://www.iclarified.com/28180/how-to-open-applications-from-unidentified-developers-in-mac-os-x-mountain-lion>

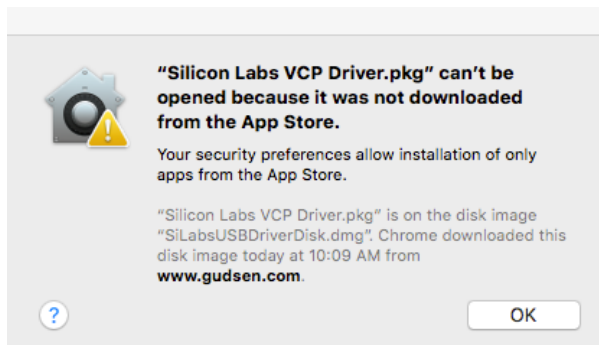

Step 2: Enter upgrade mode and start to upgrade

- ① Plug in the Moza AirCross on the computer and run the Moza Assistant software.
- ② Hold down the joystick and quick press the power button on the Moza AirCross, the LED will turn to solid blue and the below software interface will pop up.

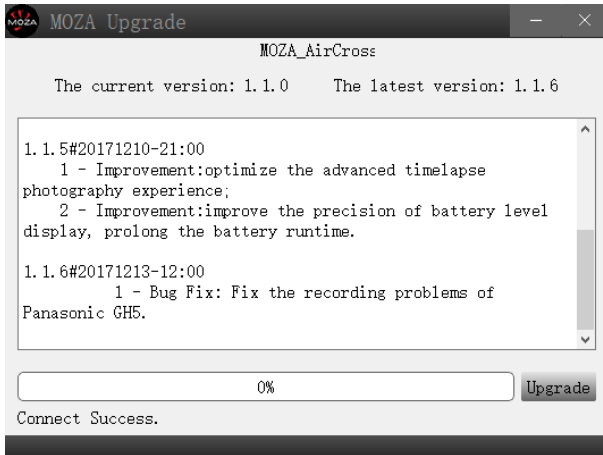

- ③ Click on "Upgrade" button to start the update. It will take about 1 to 2 minutes to finish it, the software interface will show on when the upgrade is finished:

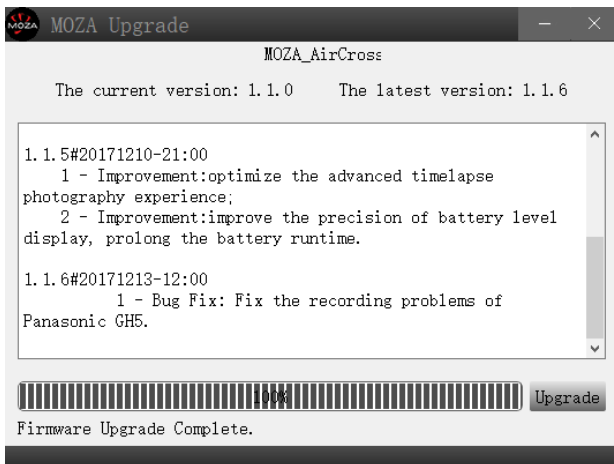

- ④ Turn off the Moza AirCross first (**important!**), then close the software, and long pressing the power button to turn on the Moza AirCross (Not enter upgrade mode, just regular power on the gimbal) and run the Moza Assistant software again.

Step 3: Gyroscope/Accelerometer Calibration

① A normal turning on will lead to the software interface below, and click on the "calibration" button on the top bar.

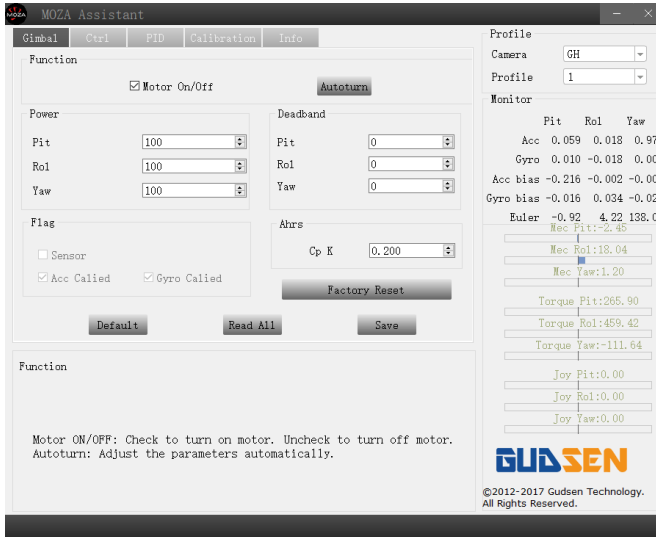

② Uncheck the "Motor On/Off" on the calibration interface.

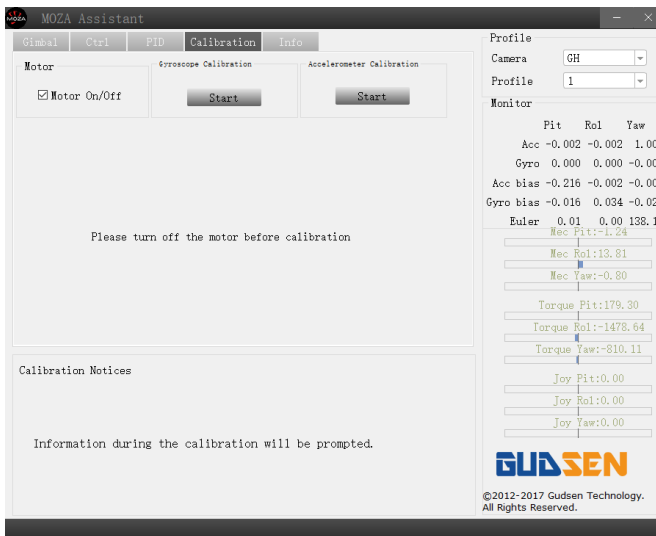

③ Here is the software interface when you shut off the motor:

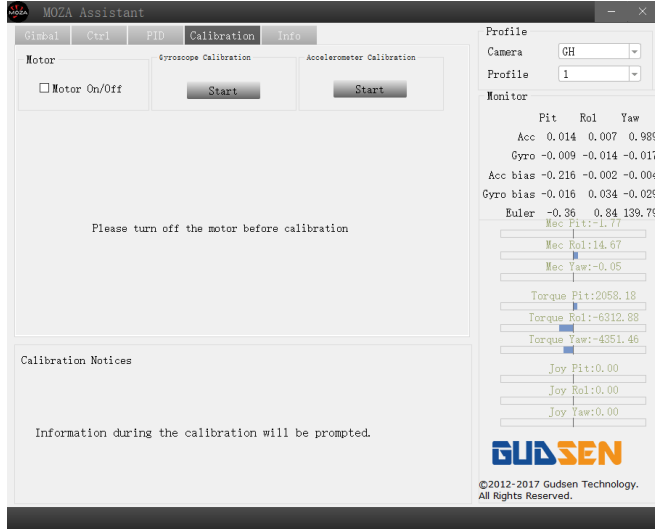

③ Please try to keep the Moza AirCross still then click on "Start" button under gyroscope calibration, Software interface below will show up which means is a successful calibration (It takes about 5-10 seconds to do the gyroscope calibration).

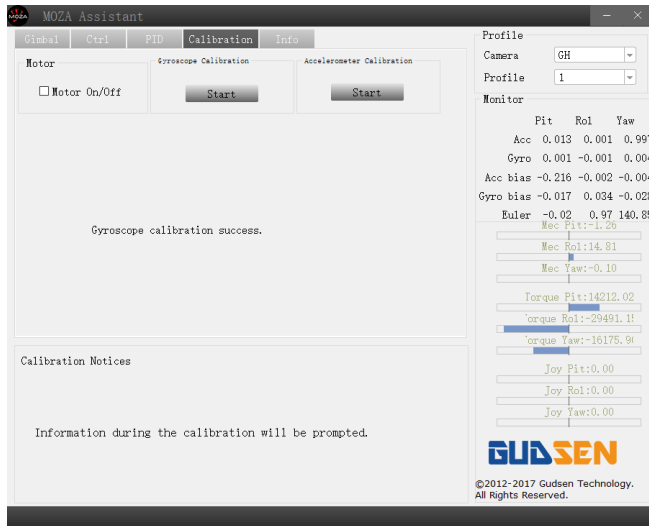

⑤ Click "Start", before accelerometer calibration, the Moza AirCross needs to be laid down on the desk like the picture suggested.

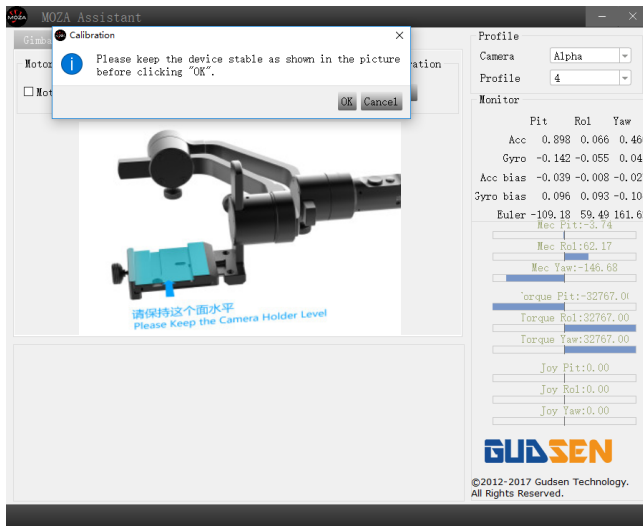

⑥ Please make sure the Camera Holder is absolutely parallel to the surface of the desk, then the "OK" button to begin the calibration, Software interface will show on when it is a successful calibration (It takes about 5-10 seconds to do the accelerometer calibration).

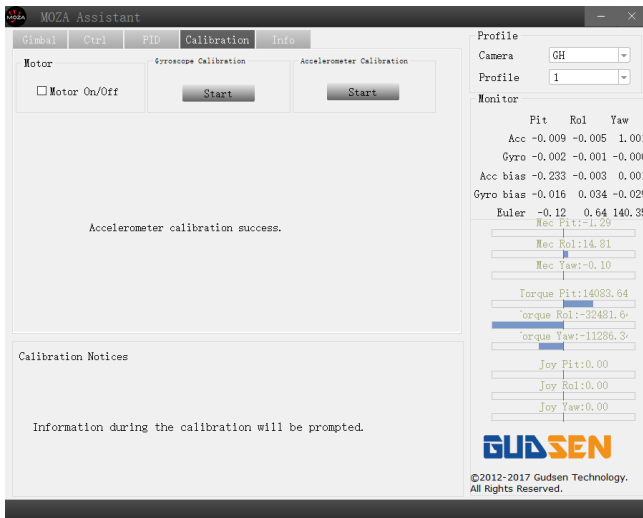

⑦ Please turn off the Moza AirCross then turn it on again via long pressing the power button, and unplug it from computer, then enjoy your Moza AirCross!

Part 2: MOZA Thumb controller firmware upgrade Tutorial

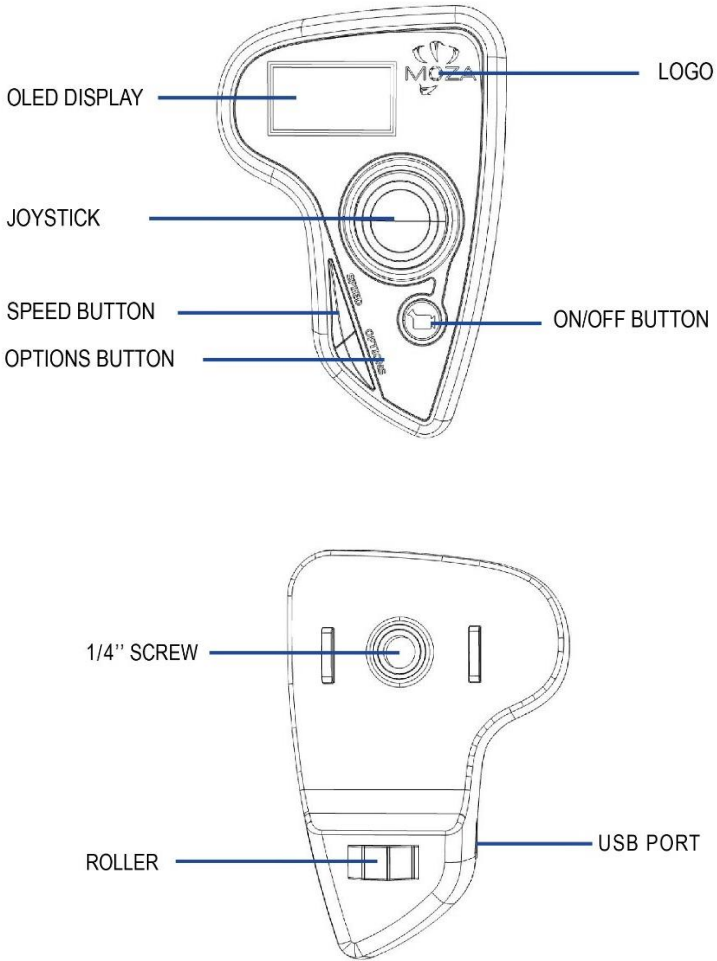

Step 1: Enter upgrade mode

With the thumb controller off, long press "SPEED" without releasing it, connect controller to computer through USB port, release "SPEED" button when the screen displays "connecting" .

Step 2

① Launch MOZA-Assistant after installing the driver. When the screen displays "Connect OK" , MOZA-Assistant enters the interface of firmware upgrade.

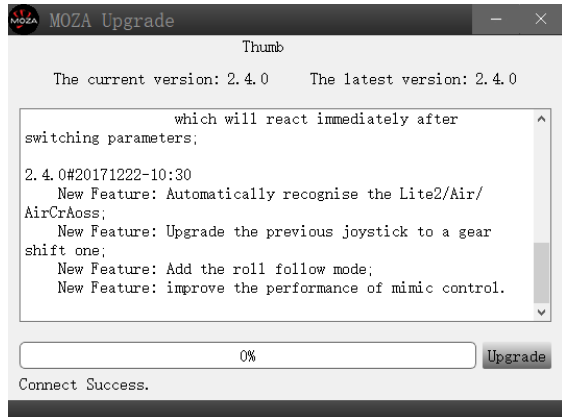
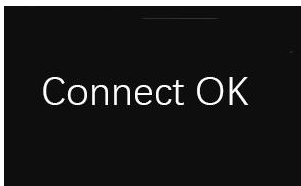
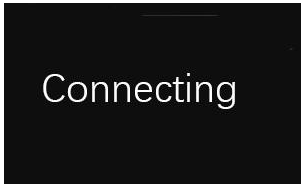

② Ensure the network being connected, MOZA-Assistant will display information of firmware version and upgrade, click "Upgrade" to start upgrading the thumb controller. When the update is done, the thumb controller display will show the "Upgraded OK" information, the firmware update for wireless thumb controller is completed!

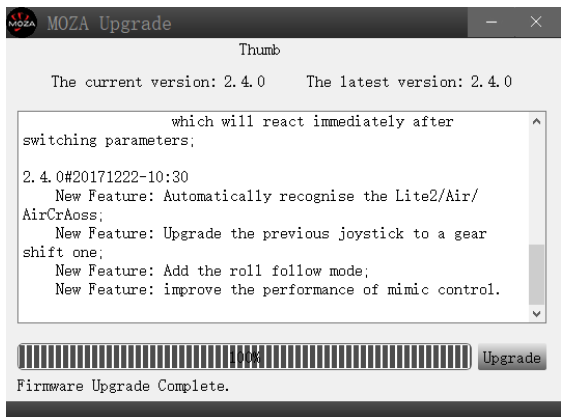
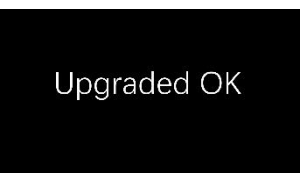
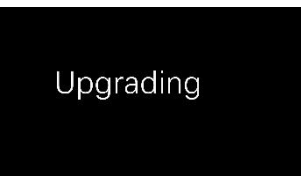

App Installation

Mobile App

MOZA Assistant App is available both in Apple Store and Google Play Store.

iOS use the keyword “MOZA ” to search or scan the QR Code to download it on your phone.

Android use the keyword“ Moza Assistant” to search or scan the QR Code to download it on your phone.



iOS



Android

Desktop App(GUI)

The GUI is a desktop software to update the gimbal firmware and change parameters of the gimbal. It is free to download at:

<http://www.gudsen.com/moza-AirCross-downloads.html>

Moza App Instruction

Home Page



Device page

Firmware Version

Bluetooth Signal

Motor On/Off button

Parameter Settings

Calibration

Version: 1.1.9

Battery Life Status

89%

Device Name

Re-Center

Joystick&normal time-lapse

Advanced time-lapse

Air X 9268

Remote Control Page

1. Recenter the Moza AirCross
2. Joystick
3. Roll Control
4. Normal Motion Time-Lapse

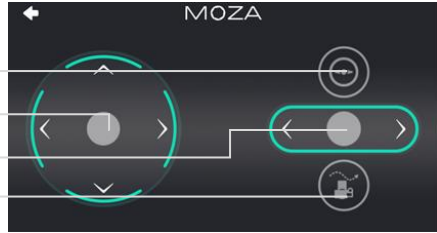

*The Roll control is only available at this page, the default angle is $0 \pm 45^\circ$.

Click on the Normal Motion Time-Lapse this page will show on. Basic time-lapse motion can be set for your Moza AirCross.

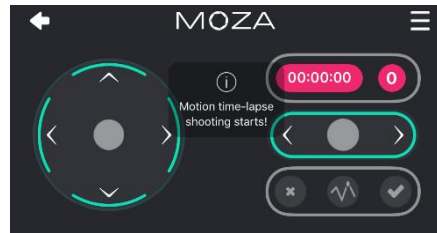

Parameter Setting

Camera Model:

There are 4 types of camera models available on start/stop remote control are listed as below:

EOS DSLR profile for Canon series(Canon 5DII /5DIII /60D /7D /70D).

Alpha profile for Sony series (a7S /a7SII /a7R /a7RII).

GH profile for Panasonic camera(GH3 /GH4).

BMD profile for Blackmagic Design camera (BMPCC /BMCC /BMPC).

*Canon 5DIV is available as well, but it needs to purchase an extra camera control wire, please contact support@gudsen.com for the solution.

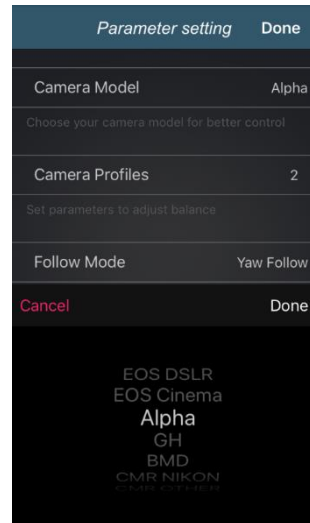

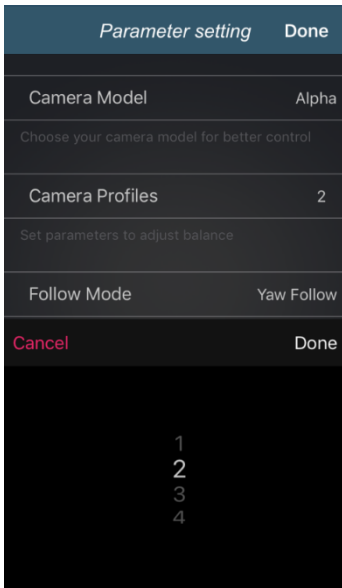

Balance Parameter

There are four groups parameters for selecting are listed as below:

1(Profile 1); 2(Profile 2);
3(Profile 3); 4(Profile 4);

Please begin with profile 4. If you get the vibration with the current profile, select a lower one until the vibration is gone. Or you can try the Auto-Tune feature at the same interface.

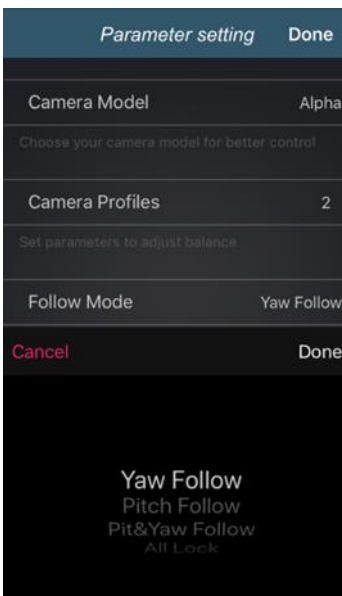

Follow Mode

There are 4 kinds of follow mode, they are listed below:

Yaw-follow mode; Pitch-follow mode;
Pitch-yaw follow mode; All-lock mode;
Roll follow mode; User-defined;

Please check the page 10 to learn more about operation mode.

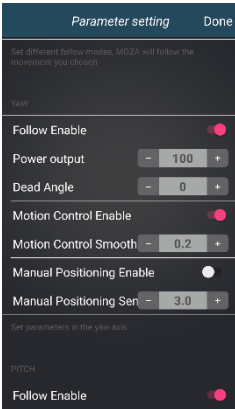

Yaw/Pitch/Roll Adjustment Arm parameter setting.

The motor parameters for yaw/pitch/roll.

Follow Enable: Enable the follow mode at the current Adjustment Arm.

Motion Control Enable: The current Adjustment Arm is no longer functional at the Motion Control when it is disable.

Manual Positioning Enable: The camera can lock on at the specific position manually when the current Adjustment Arm is no at the follow mode.

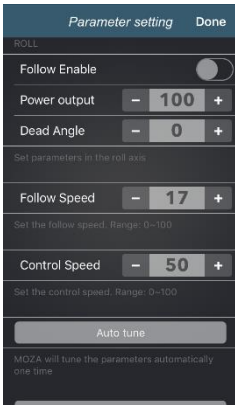

Follow Speed & Control Speed

Follow Speed

The speed of the Moza AirCross follow movement. Range from 0-100.

Control Speed

The sensitivity of joystick speed to control the Moza AirCross movement. Range from 0-100.

Auto Tune

Moza will tune the parameters automatically one time.

For some special camera setup the Auto-Tune couldn't select the best profile for your Moza gimbal, please select the profile manually.

Save Parameters

Save the parameters you set. Your Moza device will automatically use the parameters pre-set well next time.

Reset Current Parameters

Reset current parameters and restore to its default values.

Factory Reset

Rest all parameters and restore to its default values.

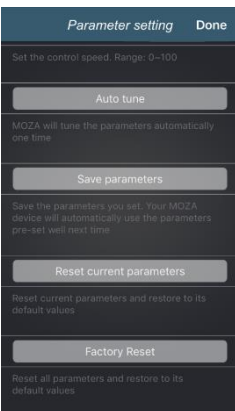

Gyroscope and Accelerometer Calibration

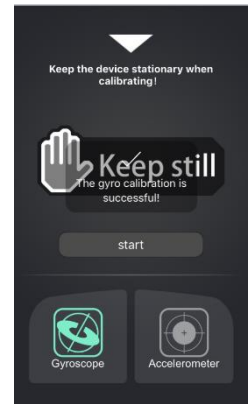
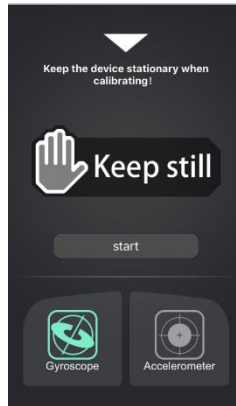
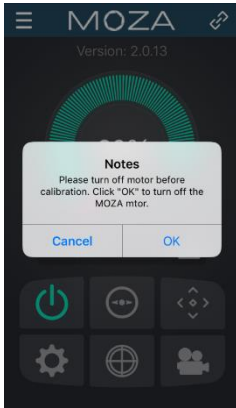

Click on the “Gyroscope/Accelerometer Calibration” button on the device page and this notification will show on. Please click on “OK” button to go on the calibration.

Then begin with the gyroscope calibration as the pictures shown below, you can go back to the device page by clicking on the white triangle button. It takes 5-10 seconds to finish gyroscope calibration, leave the Moza AirCross alone and keep it still during the calibration.

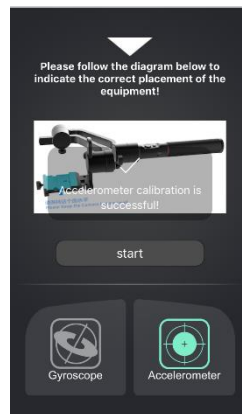
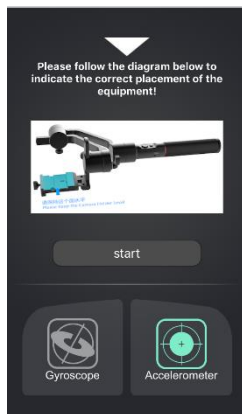

After the gyroscope calibration then begin with the accelerometer calibration. Please follow the picture to adjust it at the correct position, make sure Camera Holder is horizontal against the surface of the desk, then click on “Start” to do the accelerometer calibration. It takes about 5-10 seconds to finish the accelerometer calibration.

Advanced time lapse



① Mount the camera on the Moza AirCross then turn it on

② Set the camera on Manual Focus mode, set camera shutter, ISO, aperture and turn off the Steady Shot feature of the camera (Here we use Sony camera as an example in the tutorial).

③ Turn on mobile phone Bluetooth, run the MOZA Assistant App and connect it to the Moza AirCross.

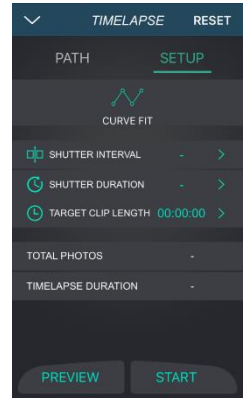
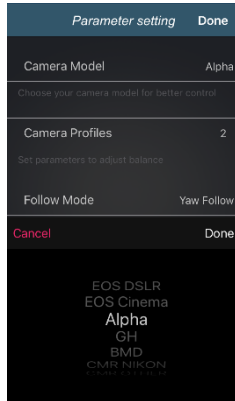

④ Enter the App main interface, select parameter setting, and switch your current camera model (Here we use Sony camera as an example in the tutorial) and save it. More information Please refer to the Support Camera Form at page 9.

⑤ Connect the camera to the Moza AirCross with the camera control cable and go back to the Home page and select Advanced Time-Lapse

⑥ Use the app to set the camera movement.

Notice: Up to 8 points can be add on the motion time-lapse.

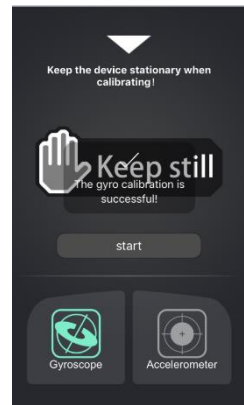
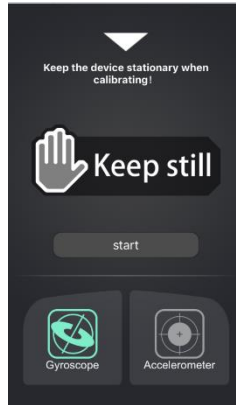
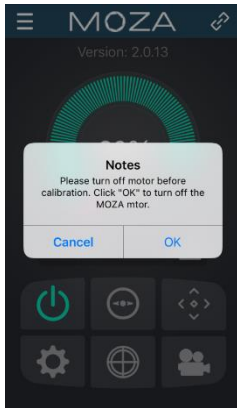

⑦ Set the shutter time, the shutter duration, the video frame rate and the total length of the shot

a. Shutter time > shutter duration > camera shutter time

Recommended Settings: Shutter duration = camera shutter time + 1S

Shutter Interval = camera shutter time + 2S

For example: the shutter time of the camera is 1, so the shutter duration is 2 and the shutter time is 3.

b. The App automatically calculates the number of images can be taken after saving the setting above.

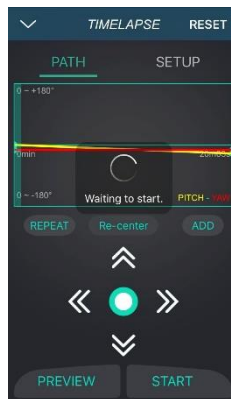

⑧ Preview the delay setting path, while the stabilizer will move according to the set trajectory, but will not take photos. After preview, you can start the time-lapse photography

Wireless Thumb Controller(Optional Accessory)

Joystick

- 1.Moza AirCross Moza AirCross remote control.
- 2.Up/down: Select the item at the menu.
- 3.Left: Go back to the upper menu.
- 4.Right: Go to the next menu or save the changes.

SPEED Button

- 1.Quick press to select the speed (L,M,H) .
- 2.Long press to select between Focusing speed and Moza AirCross moving speed.

OPTIONS Button

- 1.Quick press to switch the follow mode (Default yaw-follow, yaw-pitch follow, roll follow and all-lock).
- 2.Long press to enter the setting menu.

ON/OFF Button

- 1.Long press the button to power on/off the Moza AirCross.
- 2.Quick press to start camera REC, quick press again to stop camera REC.

Roller

- 1.Use the Roller knob to control camera focus by rolling the knob left to right. Available for Canon camera with USM lens.
- 2.Double quick press the roller to re-center the Moza AirCross.

USB Port

- 1.Charging the thumb controller.
- 2.Firmware update.

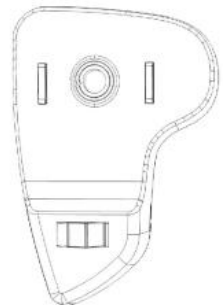
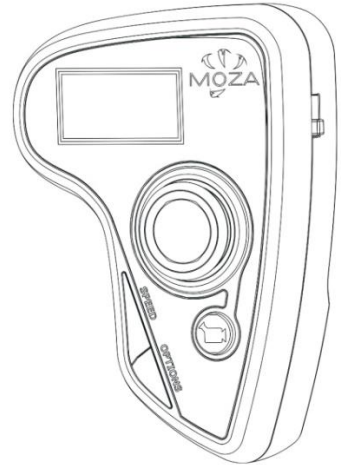

OLED Display Instruction

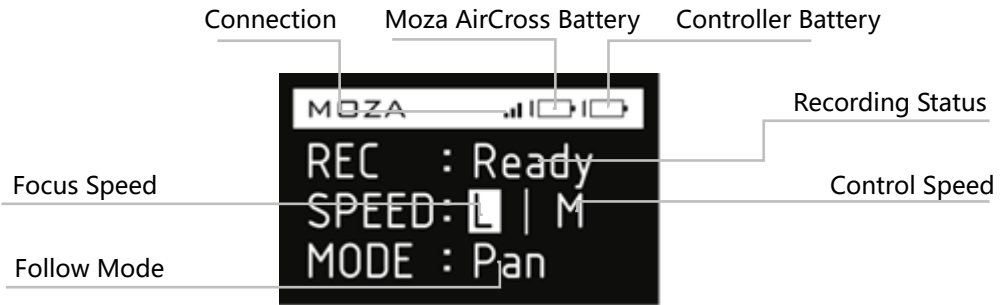

Main Menu

Long press Option Button to enter the main menu.

Functions

Function				Instruction
Pair	NO			Pair cancel
	YES			Pair start
Save	NO			Cancel the saving
	YES			Save the parameter
Camera	EOS DSLR			Select Canon series camera
	EOS Cinema			Select Canon series cinecamera
	Alpha			Select Sony Alpha series camera
	GH			Select Panasonic series camera
	BMD			Select Blackmagic series camera
	NIKON			Select Nikon series camera
Profile	OTHER			Select other brand cameras
	AUTO			Atuo-Tune
	1			Select profile 1
	2			Select profile 2
	3			Select profile 3
Motor	4			Select profile 4
	ON			Motor on
	OFF			Motor off
Follow	Follow Enable	PIT	ON	Enable pitch follow
			OFF	Disable pitch follow
		ROL	ON	Enable roll follow
			OFF	Disable roll follow
		YAW	ON	Enable yaw follow
			OFF	Disable yaw follow
	Follow Speed		Level 0	Enable Speed profile 1
			Level 1	Enable Speed profile 2
Level 2			Enable Speed profile 3	
Level 3			Enable Speed profile 4	
Level 4			Enable Speed profile 5	

Function				Instruction
Power	PIT	0--100		Adjust pitch motor power
	ROL	0--100		Adjust roll motor power
	YAW	0--100		Adjust yaw motor power
Calibrate	Motor On			Motor On
	Motor Off			Motor Off
	Gyro Calib			Gyroscope Calibration
	Acc Calib			Accelerometer Calib
	Hexa Calib			Hexahedral Calibration
Motion Control	Start			Motion Control Start
	Motion Enable	PIT	ON	Enable pitch motion control
			OFF	Disable pitch motion control
		ROL	ON	Enable roll motion control
			OFF	Disable roll motion control
		YAW	ON	Enable yaw motion control
			OFF	Disable yaw motion control
Motion Calib			Motion control calibration	
Manual Position	PIT	ON		Enable pitch manual position (Need to disable pitch follow)
		OFF		Disable pitch manual position
	ROL	ON		Enable roll manual position (Need to disable roll follow)
		OFF		Disable roll manual position
	YAW	ON		Enable yaw manual position (Need to disable yaw follow)
		OFF		Disable yaw manual position
Habits	Joystick	Mode	4 Direction	Joystick to 4 direction
			8 Direction	Joystick to 8 direction
		Up Down	PIT	Pitch control
			ROL	Roll control
			YAW	Yaw control
		Left Right	PIT	Pitch control
	ROL		Roll control	
	Reverse	YAW	Yaw control	
		Left Right	Reverse Left Right control	
	Display	Up Down	Reverse Up Down control	
Custom		1--60	Customize display (Minutes)	
Version	Always On		Set display Always-On	
			Controller firmware version	

Pair

1. Choose Pair and move the joystick rightwards to enter the secondary menu.
2. Move the joystick downwards to choose the YES option
3. Move the joystick rightwards again to enter the Pairing mode. The interface of Pairing... will appear. Then turn on Moza AirCross, the screen of the thumb controller shows OK in 5 seconds.



Note:

If the OK confirm is not shown on and you get a "Pair ERR" , please power off the Moza AirCross then turn it on and try it again. If the pair still fails, please check and update the firmware of your gimbal and wireless controller then try to pair them again (Keep both device firmware the most up to date).

Save:

Save the current setting at the Moza wireless thumb controller or it will go back to the last saving parameter.



Confirm to save and the OLED display will show "Set OK" , if it shows "Set ERR" then try the saving again.

Camera

More information please refer to the page 9 and learn the compatible camera brands which can trigger the picture taking or video shooting on the Moza AirCross.



Tips: Select "OTHER" profile and plug the shutter cable to the camera , double click on the power button on the handgrip to trigger the camera photo taking, or the advance time-lapse..

Profile

There are 4 sets of parameters are optional for different camera and lens in different weights. Please begin with profile 4. If you get the vibration with the current profile, select a lower one until the vibration is gone. Or you can try the Auto-Tune, which will tune the parameters automatically one time.

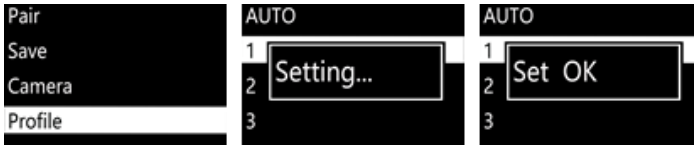

Motor

Turn on or off the motor.



Follow

"Follow Enable: is set to enable or disable the follow function at the current Adjustment Arm.

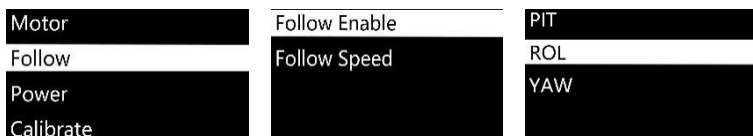

“Follow Speed” is set for the movement speed along with the operator. Five level profiles are available.

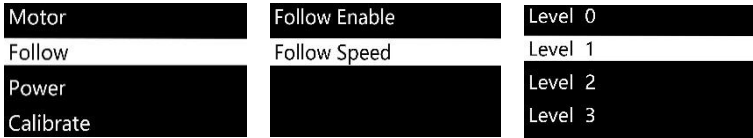

Power

Motor torque adjustment, please keep the original parameter.



Calibrate

Gyroscope and Accelerometer Calibration. More information please refer to page 13 or page 23.



Motion Control

Please refer to page 33 to learn how to set the Motion Control

Manual Position

Enable the Manual Position then use your hand to move the lens towards to the angles you need, then let go and it will stay on the current position.

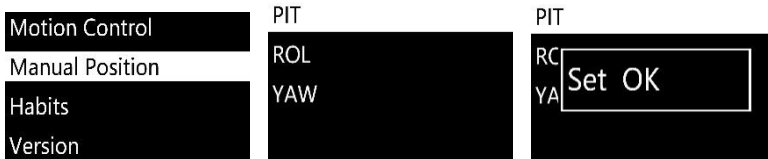

Tips: Disable the follow mode on the current Adjustment Arm before enable the Manual Position.

Habits

Set the habits for joystick and display.

Mode

You can set the joystick to 4 direction or 8 direction.



Remap the joystick

Up Down → PIT: Up or down to control the Pitch Adjustment Arm

Up Down → ROL: Up or down to control the Roll Adjustment Arm

Up Down → YAW: Up or down to control the Yaw Adjustment Arm

Left Right → PIT: Left or Right to control the Pitch Adjustment Arm

Left Right → ROL: Left or Right to control the Roll Adjustment Arm

Left Right → YAW: Left or Right to control the Yaw Adjustment Arm

Reverse

Reverse the current joystick direction.

Custom

Customize turn off the display after 1-60 minutes.

Always On

Display will always on.



Version

View the current firmware version of the wireless thumb controller.



MOZA Mimic Motion Control Tutorial Guide

Notice: Only apply to version D of the MOZA thumb controller

Mimic Motion Control

1. Pair Moza AirCross with the thumb controller (which has been paired after manufacture).
2. Turn Moza AirCross on.
3. Calibration should be done when you use this function for the first time or drifts and unstable situations occur, please refer to mimic control calibration.
4. Long press "OPTIONS" to enter the menu. Select "Motion Control" >> "Start" to enter the mimic control mode.

Motion Control

Manual Position
Habits
Version

Start

Motion Enable
Motion Calib

5. The screen displays parameters of each axis after entering the mimic control mode. If "Error" pops out on the screen, please check the thumb controller code or try it again.

Motion Ctrl
Pit: -000
Rol: -002
Yaw: -063

6. If the attitude of Moza AirCross is inconsistent with the thumb controller in mimic control mode, long press "SPEED" button to pause mimic control, turn the thumb controller to a desired position, then release "SPEED" to restart control when both

attitudes become consistent.

7. Move the joystick leftwards to exit the mimic control mode.



Select "ON" to enable the motion control on the current Adjustment Arm . Select "OFF" to disable this function.

Mimic control calibration

1. Place the thumb controller and Moza AirCross well like figure 1
2. Long press "OPTIONS" to enter the menu. Select "Motion Control" >> "Motion Calib" to start calibration.

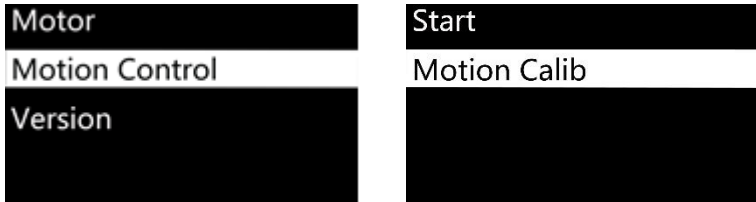

3. Keep the thumb controller still, until the screen displays "Success" or "Fail" . If it shows "Fail" please make sure wireless thumb controller is keeping still or if it is a D version controller.

Specifications

Moza AirCross	
Weight	896g(without battery)
Dimensions	378*175*193mm
Max Payload	1800g
Till Rotation Range	360°
Roll Rotation Range	360°
Yaw Rotation Range	360°
Working Voltage	9.8-12.6V
Dynamic Current	200mA
Static Current	100mA
Battery Life	12hrs
Bluetooth	Bluetooth 4.0
Valid range	5m
USB Input	Micro USB 2.0
DC Input	12V
DC Output	7.4V

Battery	
Type	Li-ion
Capacity	2000mAh
Output Voltage	4.2V(max)
Output Current	6A (max)

Charger	
Input Voltage	5V DC
Output Voltage	4.2V DC
Output Current	500mA X 4
Charging Time	4hrs

Wireless Thumb Controller	
Weight	100g
Battery Capacity	600mAh
Battery Voltage	3.7V
Working Current	50mA
Rest Current	10mA
Standby Time	24h
Wireless Type	2.4G
Control Range	50M
Charging Voltage	5V
Charging Time	2h

Warranty

1. Questions, Support, Service and Warranty contact support@gudsen.com.
2. All shipment must be approved by the Technical Support before shipment. Consumers are responsible for shipping costs. Technical Support will examine and identify the problem and responsibility; If the issue or issues are a manufacturing defect Gudsen will cover all testing costs, material costs, labor costs, and return shipping.
3. If the product is deemed not to be covered by the warranty. We will contact the customer describing the repairs and costs before repairing the stabilizer. Customer is responsible for return shipping;
4. Consumers can contact support@gudsen.com for more details of maintenance process.
5. Moza AirCross is covered by 12 months warranty. The limited warranty does not apply to accessories or consumable parts. For more details on the warranty policy www.gudsen.com.

FAQ & Customer Support

1.How to setup Moza AirCross?

Take out the Moza AirCross and battery from the box, make sure the battery is full charge; Balance the camera until the camera lens can keep horizontal still whatever it is towards up or down, left or right, then you can turn it on and give it a try.

2.What cause a vibration problem?

The payload profile is not match to the real weight of your setup will cause the vibration problem. You can try the Auto-Tune at the Mobile App to fix this problem.

3.Quick review of Joystick and Power Button control

Joystick: One quick press: Yaw-follow mode. Double quick press: Tilt-yaw follow mode. Triple quick press: All-lock mode. Four times quick press: Roll-follow mode. Long press/quick press again: Enable sleeping mode/ wake up ;

Power Button: One quick press: Start/Stop recording. Double quick press: Photo-taking. Triple quick press: auto-center. Four times press: Enable roll control. Long press: Power on/off the Moza AirCross.

4.How to set the camera recording function on Moza AirCross?

(1) Plug in the camera control cable.

(2) Select the right camera profile and save it. (Sony--ALPHA, Canon--EOS DSLR, Panasonic--GH)

(3) Click on the Power Button on Moza or wireless thumb controller to start.

5.How to connect to the Mobile App?

Download (iOS: Search MOZA at App store; Android: Search MOZA at Google Play)Turn on the phone Bluetooth (Android need to give the phone full access) ,run the App and power on the Moza AirCross, Click on the "Search" button to locate your Moza device.

Customer Support

Please send your inquiry to www.gudsen.com for the technical assistant.

Index

1. Gimbal Balance	07
2. Dual hand setup	09
3. Press commend Logic	10
4. Thumb controller function	27
5. Parameter setting & Auto-Tune	
5.1APP Select profile	21-22
5.2 Thumb controller.....	30
6. Camera Control Feature	
6.1 Camera control cable.....	09
6.2APP.....	20
6.3 Thumb controlle.....	30
7. Roll Motor Control	
7.1Joystick control.....	10
7.2APP control.....	20
7.3Thumb controller control.....	32
8. Follow Mode selection	
8.1Jostick.....	10
8.2APP.....	21
8.3Thumb controlle.....	26
9. Manual position Switch	
9.1APP.....	22
9.2Thumb controller.....	31
10. Advanced Time-Lpase.....	24
11. Motion Control.....	33
12. Gimbal Firmware update.....	11
13. Thumb controller Firmware update.....	16
14. Calibration.....	13



GUDSEN

